

**COMPREHENSIVE
ARCHITECTURAL SOLUTIONS**

TAITON[®]



Edition #8

www.taiton.in

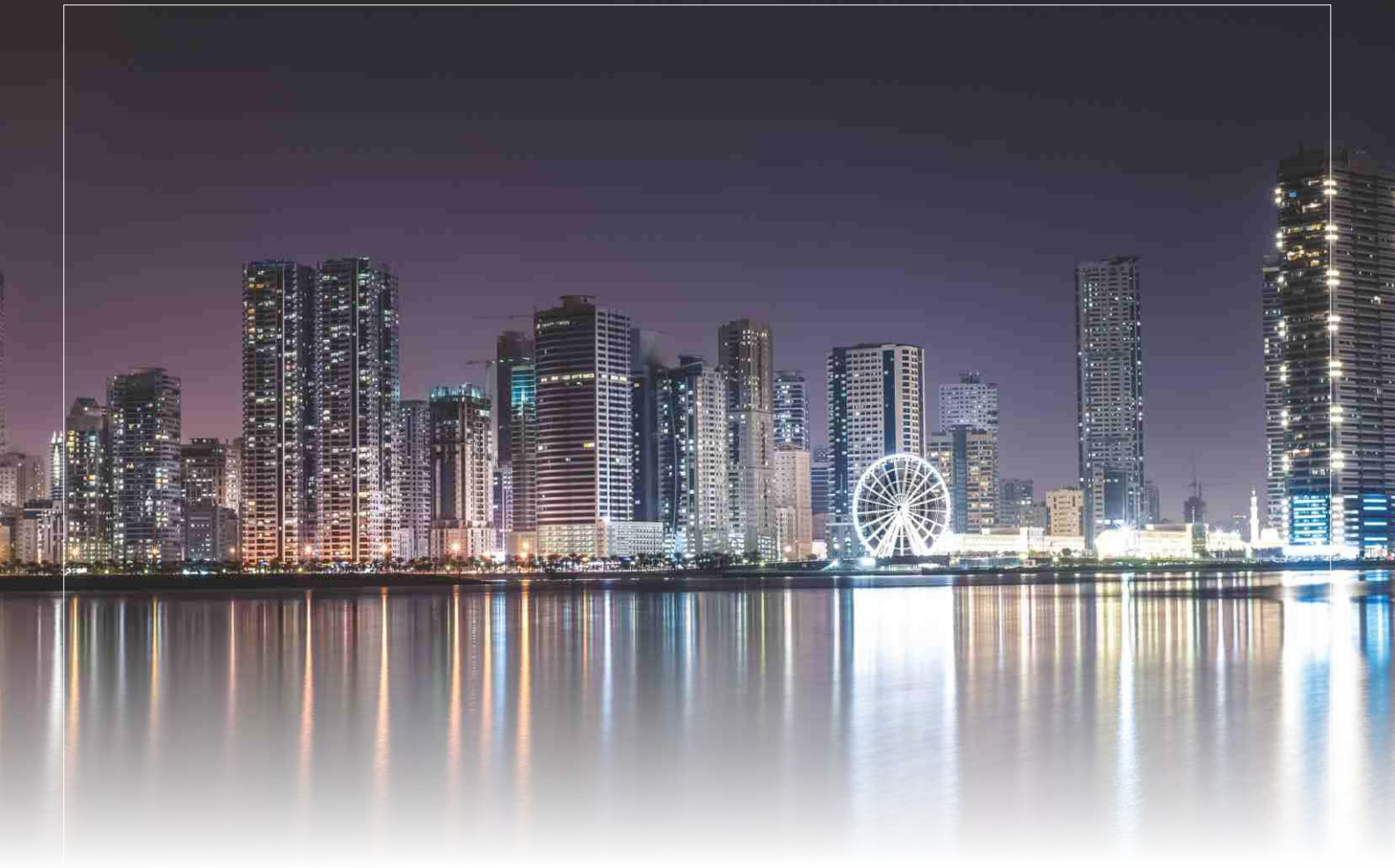

ABOUT US

The World of TAITON provides you with the Largest and most Comprehensive product range which has been intelligently crafted to suit the modern Hi-tech commercial and residential establishments. We have a rich tradition of manufacturing and distributing high Quality Architectural Hardware which meets and exceeds expectations.

The tradition has inspired us to foray into diverse fields of premium & exclusive products to decorate your interior spaces. Our diversified product portfolio is strategically divided into 9 verticals. In the current dynamic world infrastructural development is witnessing the rapid advancement, hence, there is a requirement to continuously innovate the products utilizing latest technologies to offer solutions that match perfectly to the need of modern customers.

Being a Quality conscious firm, we never compromise with Quality of our products. For that, we conduct an elaborate research on the materials to be used and the prevailing market trends. We ensure that our products undergo strict quality checks on various parameters like durability, finishing and robustness before they are delivered to our customers.

TAITON will keep challenging itself in the new era, dedicating to supply more beautiful and high quality products for a better living. We offer prompt & courteous delivery of our products and efficient customer service.

Exceptional functional & technical expertise coupled with extensive industry knowledge makes TAITON the ideal choice for implementation of your desires into reality.

THE WORLD OF TAITON

GLASS HARDWARE



Glass Facade Hardware

DOOR CONTROL HARDWARE



Wooden & Metal Door Hardware

AUTOMATICS



Automatic Doors

TAVIC
COMPREHENSIVE PARTITION SOLUTIONS



Wardrobe & Slim Partitions

maxia®



Luxury Shower Cubicles

ELECTRONIC LOCKS



Hotel RFID & Digital Locks

MOVABLE PARTITIONS



Acoustic & Glass Movable Partitions

SMART SWITCH FILM



Switchable Privacy Film

RAILINGS

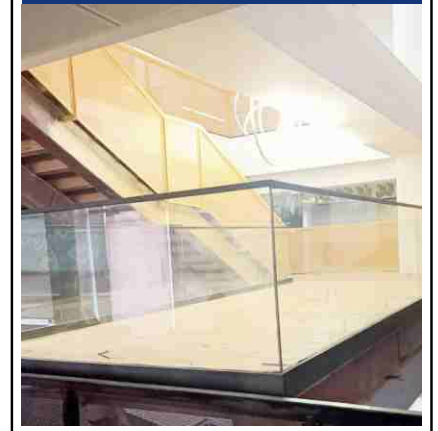

Stainless Steel & Aluminium Railings

INDEX

	PAGES
Patch Fittings	01-03
Door Handles	04-06
Wall Connecting Profile & Door Rails	07
Office Partition Hardware	08
Shower Cubicle Fittings	09-14
Sliding Door Systems	15-17
Sliding Folding Systems	18-19
Spider Fittings	20-25
Door Control Hardware	26-29
Floor Springs	30
Door Closers	31
TAITON MAXIA – Exclusive Luxury Shower Cubicles	32-40
Automatic Sliding Doors, Panic Breakout Door	41-44
Automatic Swing Doors	45-46
Automatic Curved Sliding Door	47
Revolving Doors & Hand Sensor	48
Motion Sensor & Auto Door Accessories	49-50
Telescopic Sliding Frameless Glass Door	51-52
RFID Card Locks	53-54
Elevator Control & DND System	55
Digital Glass Door Locks	56
Digital Biometric Door Locks & Drawer Locks	57-58
Acoustic & Glass Movable Partitions	59-62
Wardrobe Sliding Systems	63-64
Railings	65-68
Smart Switch Film	69

PATCH FITTINGS

TAITON features the finest and most comprehensive range of patch fittings to meet the aesthetic as well as the functional requirement of the space. These not only make the facades look visually appealing but also provide the strength to the façade.

Made from heavy duty materials, the patch fittings are available in various finishes to match with the interiors. These patch fittings are suitable for glass thickness 8-12mm and manufactured as per international standards for quality, stability and safety.



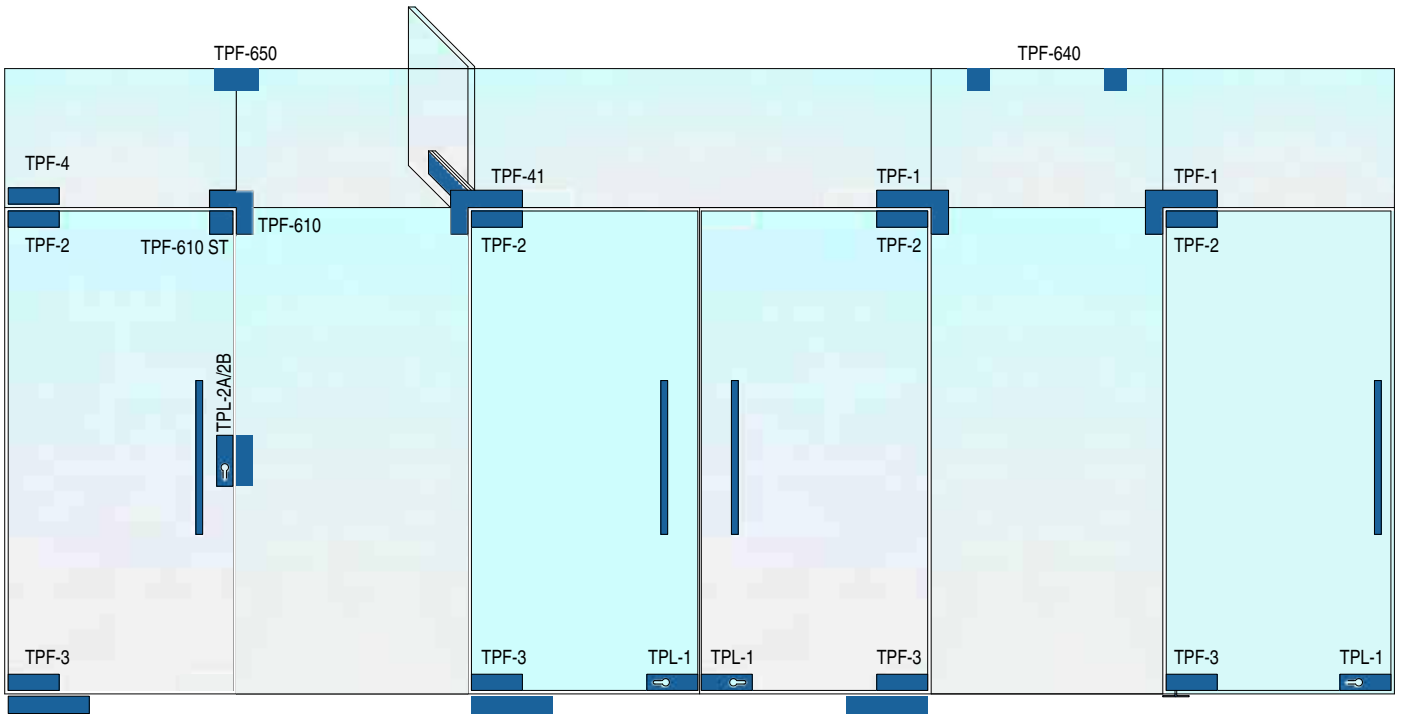

SSS
 BM
 GP
 RGP

MATERIAL: SS 304

PREMIUM SERIES



SSS	₹ 2,600
BM	₹ 2,800
GP	₹ 3,000
RGP	₹ 3,400

TPF-1
Over Panel Side Panel
Connecting Patch with Pivot



SSS	₹ 1,550
BM	₹ 1,700
GP	₹ 1,850
RGP	₹ 2,050

TPF-2
Top Patch



SSS	₹ 1,550
BM	₹ 1,700
GP	₹ 1,850
RGP	₹ 2,050

TPF-3
Bottom Patch



SSS	₹ 2,200
BM	₹ 2,400
GP	₹ 2,600
RGP	₹ 2,800

TPF-4
Wall Mounted Over Panel Patch with
Pivot



SSS	₹ 2,000
BM	₹ 2,200
GP	₹ 2,400
RGP	₹ 2,600

TPF-610
Over Panel Side Panel Connector



SSS	₹ 4,200
BM	₹ 4,550
GP	₹ 4,700
RGP	₹ 4,800

TPF-610 R/L
Triple Glass Connector with Fin (Right/Left)

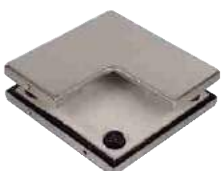

SSS	₹ 2,650
BM	₹ 3,000
GP	₹ 3,100
RGP	₹ 3,250

TPF-610-ST
Over Panel Side Panel Connector with
Stopper (One side opening of door)



SSS	₹ 3,500
BM	₹ 3,850
GP	₹ 3,900
RGP	₹ 4,100

TPF-620
Quadruple Connector



SSS	₹ 4,200
BM	₹ 4,550
GP	₹ 4,700
RGP	₹ 4,800

TPF-630 F
Double Glass Connector with Fin

PATCH FITTINGS

SSS	₹ 900
BM	₹ 1,000
GP	₹ 1,200
RGP	₹ 1,400



TPF-640
Wall to Glass Clamping Patch

SSS	₹ 1,200
BM	₹ 1,500
GP	₹ 1,600
RGP	₹ 1,700



TPF-650
Glass to Glass Connecting Patch to Wall/Ceiling

SSS	₹ 1,350
BM	₹ 1,700
GP	₹ 1,900



TPF-660
Glass to Glass Connector

SSS	₹ 5,750
BM	₹ 6,100
GP	₹ 6,350



TPF-41 R/L
Over Panel Side Panel Connector with Fin (Right/Left)

SSS	₹ 9,350
BM	₹ 9,700
GP	₹ 9,950



TPF-51
Over Panel Connector for Back to Back Doors

SSS	₹ 300
BM	₹ 380
GP	₹ 470
RGP	₹ 490



TFS-ACC-GDP
Top Pivot for Patch/Point Fitting Doors

Finishes Available



Satin



Black Matte



Gold



Rose Gold

PATCH LOCKS



SSS	₹ 2,500
BM	₹ 2,800
GP	₹ 3,100
RGP	₹ 3,600

TPL-1
Corner Patch Lock with Strike Plate



SSS	₹ 3,600
BM	₹ 3,750
GP	₹ 3,900
RGP	₹ 4,400

TPL-2A
Center Patch Lock with Strike Box



SSS	₹ 1,800
BM	₹ 1,900
GP	₹ 2,100
RGP	₹ 2,400

TPL-2B

• Key Outside & Knob Inside

SSS	₹ 3,000
-----	---------



TPL-3A/3B
Glass Door Lock with Strike Box



SSS	₹ 2,800
-----	---------

TPL-3A
Glass Door Lock with Strike Plate

SSS	₹ 2,150
BM	₹ 2,600
GP	₹ 3,000
RGP	₹ 3,500



TPL-4A-N-S
Glass Door Lock with Strike Plate/Box (Without Cutout)



TPL-4A/4B-N

SSS	₹ 2,900
BM	₹ 3,500
GP	₹ 4,100
RGP	₹ 4,500

SSS	₹ 1,950
BM	₹ 2,100
GP	₹ 2,300
RGP	₹ 2,500

TPL-TL
Thumb Turn Lock with Strike Plate/Box (Without Cutout)

SSS	₹ 2,600
BM	₹ 2,800
GP	₹ 3,000
RGP	₹ 3,200



TPL-TL-SB

POINT FIXED GLASS CONNECTORS



SSS	₹ 13,500
-----	----------

TSSPL-SDL-G
Sliding Door Lock With Claw Type Dead Bolt & Strike Box



TSSPL-SDL
Sliding Door Lock With Claw Type Dead Bolt & Strike Plate

SSS	₹ 10,000
-----	----------



TPF-GC-3
Wall to Glass Connector

SSS	₹ 1,000
-----	---------

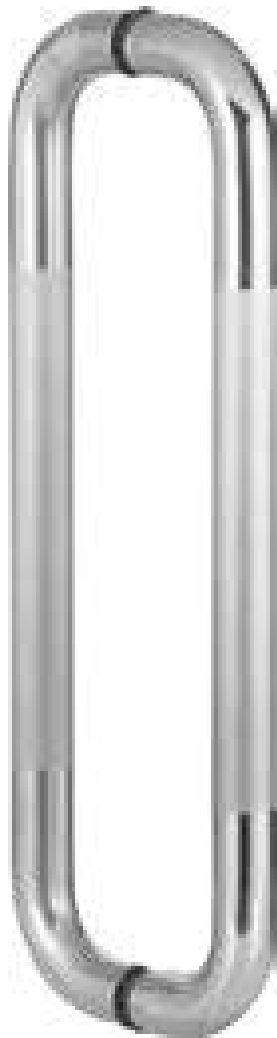

Product Code	Handle Diameter	Center to Center of Hole	Overall Length of Handle	Finish	MRP
TGH-11 19mmx152mmx171mm	19mm	152mm	171mm	PSS	₹ 1,300
				BM	₹ 1,400
				GP	₹ 1,700
				RGP	₹ 1,800
TGH-11 19mmx250x269mm	19mm	250mm	269mm	SSS	₹ 1,500
TGH-11 25mmx300x325mm	25mm	300mm	325mm	SSS	₹ 1,800
				PSS	₹ 1,900
				BM	₹ 2,000
				GP	₹ 2,100
				RGP	₹ 2,200
TGH-11 25mmx425x450mm	25mm	425mm	450mm	SSS	₹ 2,000
				PSS	₹ 2,100
				BM	₹ 2,200
				GP	₹ 2,500
				RGP	₹ 2,600
TGH-11 32mmx568x600mm	32mm	568mm	600mm	SSS	₹ 2,800
				PSS	₹ 3,000

TGH-11
D Type Handle

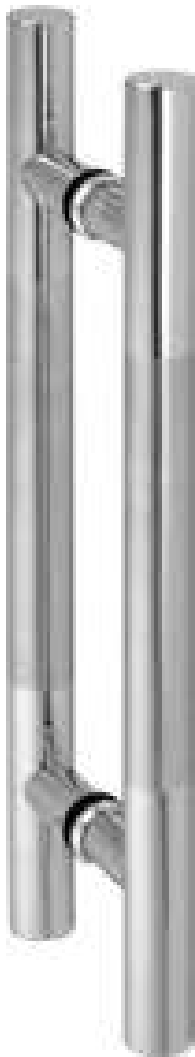

TGH-55
H Type Handle

Product Code	Handle Diameter	Center to Center of Hole	Overall Length of Handle	Finish	MRP
TGH-55 25mmx250mmx300mm	25mm	250mm	300mm	SSS	₹ 1,800
				PSS	₹ 1,900
TGH-55 25mmx302x450mm	25mm	302mm	450mm	SSS	₹ 2,000
				PSS	₹ 2,100
				BM	₹ 2,800
				GP	₹ 3,500
				RGP	₹ 3,700
TGH-55 25mmx350x450mm	25mm	350mm	450mm	SSS	₹ 2,000
				PSS	₹ 2,100
TGH-55 32mmx302x450mm	32mm	302mm	450mm	SSS	₹ 2,200
				PSS	₹ 2,300
				BM	₹ 3,000
				GP	₹ 3,700
				RGP	₹ 3,900
TGH-55 25mmx450x600mm	25mm	450mm	600mm	SSS	₹ 2,300
TGH-55 32mmx450x600mm-A	32mm	450mm	600mm	SSS	₹ 2,500
				BM	₹ 3,300
				GP	₹ 4,000
				RGP	₹ 4,200
TGH-55 32mmx480x600mm-B	32mm	480mm	600mm	SSS	₹ 2,500
TGH-55 32mmx600x900mm-A	32mm	600mm	900mm	SSS	₹ 3,500
TGH-55 32mmx700x900mm-B	32mm	700mm	900mm	SSS	₹ 3,500
				BM	₹ 4,200
				GP	₹ 5,000
				RGP	₹ 5,300
TGH-55 32mmx1100X1300mm	32mm	1100mm	1300mm	SSS	₹ 7,000
				BM	₹ 7,300
				GP	₹ 7,600
				RGP	₹ 8,000

DOOR HANDLES

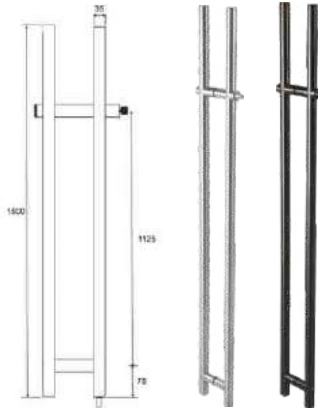

TGHL-55
Glass Door Handle with Integral Lock

Handle Diameter	Center to Center of Hole	Overall Length of Handle	Finish	MRP
35mm	1125mm	1500mm	SSS	₹ 18,500
35mm	1125mm	1500mm	Black Matt	₹ 24,000
35mm	1125mm	1500mm	GP	₹ 27,500
35mm	1125mm	1500mm	RGP	₹ 30,000



TGH-552-ED
Glass Door Handle

Handle Section	Center to Center of Hole	Overall Length of Handle	Finish	MRP
40mmx10mm	298mm	450mm	SSS	₹ 4,450
40mmx10mm	298mm	450mm	BM	₹ 4,800
40mmx10mm	450mm	600mm	SSS	₹ 5,250
40mmx10mm	450mm	600mm	BM	₹ 5,600



TGH-554-ED
Glass Door Handle

Handle Section	Center to Center of Hole	Overall Length of Handle	Finish	MRP
20mmx40mm	380mm	400mm	SSS	₹ 3,400
20mmx40mm	380mm	400mm	BM	₹ 3,700
20mmx40mm	780mm	800mm	SSS	₹ 5,500
20mmx40mm	780mm	800mm	BM	₹ 5,800



TGH-664
Hole to Hole Adjustable Handle

Handle Diameter	Center to Center of Hole	Overall Length of Handle	Finish	MRP
32mm	300~800mm	900mm	SSS	₹ 5,950



TGH-11-D
Offset Handle



TGH-11-D-BM
Offset Handle

Handle Diameter	Center to Center of Hole	Overall Length of Handle	Finish	MRP
25mm	250mm	275mm	SSS	₹ 3,000
			Black Matte	₹ 3,500
25mm	300mm	325mm	SSS	₹ 3,300
			Black Matte	₹ 3,700
25mm	450mm	475mm	SSS	₹ 3,500
			Black Matte	₹ 4,000
25mm	600mm	625mm	SSS	₹ 3,800
			Black Matte	₹ 4,300



WALL CONNECTING PROFILE SYSTEM

TGL-WCP-22

SILVER
 SSS
 BM
 GM

	3Mtr	4Mtr
SILVER	₹ 3,600	SILVER ₹ 4,800
SSS	₹ 3,900	BM ₹ 5,860
BM	₹ 4,400	5Mtr
GM	₹ 5,400	SILVER ₹ 6,000
RGM	₹ 5,800	

Features:

- Attached with ceiling, floor or wall
- Available in lengths of 2mtr, 3mtr & 4mtr
- Available for 8mm, 10mm & 12mm Glass
- Does not require any glass preparation
- Easy and simple installation of the glass
- Low maintenance cost
- End Cap for better aesthetics
- Gaskets Included. Please specify glass thk while ordering

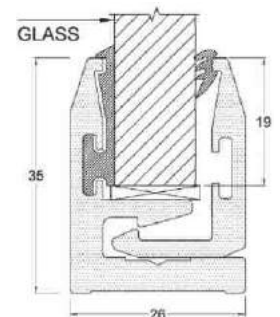

GLASS DOOR RAILS

Features:

- Easy to Install
- Quick Door Assembly
- Pre Installed Hardware
- End Cap for Better Aesthetics
- Removable Clip on SS Covers
- Firm Grip with Glass
- For Glass Thickness 10 & 12mm



TDR-1

Top Rail (Available in 1mtr & 1.2mtr Length)

1Mtr	₹ 5,850
1.2Mtr	₹ 6,650



TDR-2

Bottom Rail (Available in 1mtr & 1.2mtr Length)

1Mtr	₹ 6,450
1.2Mtr	₹ 7,250

OFFICE PARTITION HARDWARE

SILVER
 BM

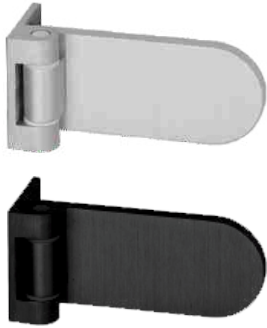

TAGH-1
Wall to Glass 90°
Aluminium Door Hinge
for Door Weight = 45kg

SILVER	₹ 2,550
BM	₹ 2,650



TAGH-11
Aluminium Handle

SILVER	₹ 2,750
BM	₹ 3,400



TAGL-11
D Type Glass Door Lock

SILVER	₹ 9,000
BM	₹ 9,650



TAGH-33
Aluminium Handle

SILVER	₹ 2,750
BM	₹ 3,400



TAGL-11-SB
Strike Box for D Type
Glass Door Lock

SILVER	₹ 4,600
BM	₹ 4,900



TAGL-11-SP
Strike Plate for D Type
Glass Door Lock
(SS 304, Finish: SSS)

SILVER	₹ 400
BM	₹ 500



TAGHL-11-SET
Lock & Handle Set
Available in K2K & K2N

TAGHL-11-K2K
SILVER ₹ 10,900
BM ₹ 11,400

TAGHL-11-K2N
SILVER ₹ 11,000
BM ₹ 11,500



K2K

K2K



K2N

K2N



TAGHL-33-SET
Lock & Handle Set
Available in K2K & K2N

TAGHL-33-K2K
SILVER ₹ 10,900
BM ₹ 11,400

TAGHL-33-K2N
SILVER ₹ 11,000
BM ₹ 11,500



K2K

K2K



K2N

K2N

SHOWER CUBICLE FITTINGS

Taiton features standard range of shower cubicle fittings such as shower hinges, shower screen brackets & connectors, towel bar handles, knight head accessories & plastic profiles.

Shower hinges are available in SS 304 in various finishes to be selected from as per taste.

Glass connectors are available in SS 304 Grade.

Shower cubicle fittings are suitable for glass thickness 8mm & 10mm.





SHOWER HINGES

SSS PSS BM GP RGP

MATERIAL: SS 304

Finishes Available

SSS	₹ 2,300
PSS	₹ 2,300
BM	₹ 2,600
GP	₹ 3,500
RGP	₹ 3,700

TSH-1
Wall to Glass Hinge

SSS	₹ 2,400
PSS	₹ 2,400
BM	₹ 2,900
GP	₹ 3,600
RGP	₹ 3,800

TSH-OFS-1
Wall to Glass Offset Hinge

SSS	₹ 3,400
PSS	₹ 3,400
BM	₹ 4,000
GP	₹ 5,500
RGP	₹ 5,700

TSH-2
Glass to Glass Hinge 180°



• Rose Gold available against order

SSS	₹ 7,800
PSS	₹ 7,800
BM	₹ 9,100
GP	₹ 9,500
RGP	₹ 9,900

TSH-2T
Double Action 3-Way 'T' Hinge

SSS	₹ 3,600
PSS	₹ 3,600
BM	₹ 4,200
GP	₹ 5,600
RGP	₹ 6,000

TSH-3
Glass to Glass Hinge 135°

SSS	₹ 3,900
PSS	₹ 3,900
BM	₹ 4,500
GP	₹ 6,000
RGP	₹ 6,200

TSH-4
Glass to Glass Hinge 90°

SSS	₹ 2,050
PSS	₹ 2,050
BM	₹ 2,400
GP	₹ 3,300
RGP	₹ 3,500

TSH-5
Wall to Glass Bracket



MATERIAL: SS 304

GLASS CONNECTORS



TGC-1
Glass Connector for
Wall / Floor Mounting

SSS	₹ 380
PSS	₹ 380
BM	₹ 600
GP	₹ 650
RGP	₹ 700



TGC-2
Glass to Glass Connector 135°

SSS	₹ 550
PSS	₹ 550
BM	₹ 800
GP	₹ 850
RGP	₹ 950



TGC-3
Glass to Glass Connector 90°

SSS	₹ 550
PSS	₹ 550
BM	₹ 800
GP	₹ 850
RGP	₹ 950



TGC-4
Wall to Glass Connector 90°

SSS	₹ 500
PSS	₹ 500
BM	₹ 770
GP	₹ 820
RGP	₹ 920



TGC-5
Glass to Glass Connector 180°

SSS	₹ 550
PSS	₹ 550
BM	₹ 800
GP	₹ 850
RGP	₹ 950

Finishes Available



Satin



Polish



Black Matte



Gold

Rose Gold available against order

TOWEL BAR HANDLES

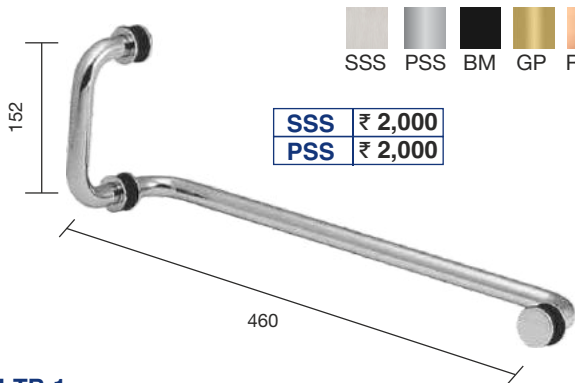

TGH-TB-1
Towel Bar with Handle (Ø19 mm)

SSS	₹ 2,000
PSS	₹ 2,000



TGH-TB-1 BM
Towel Bar with Handle (Ø19 mm)

BM	₹ 2,600
----	---------

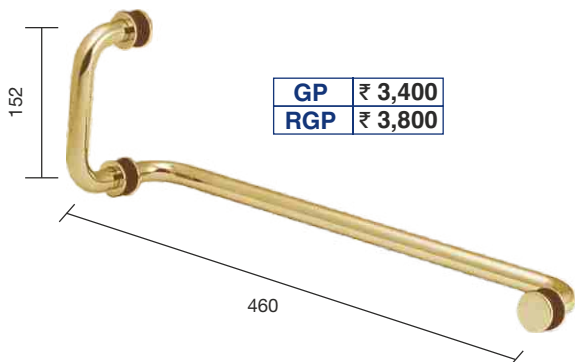

TGH-TB-1 GOLD
Towel Bar with Handle (Ø19 mm)

GP	₹ 3,400
RGP	₹ 3,800

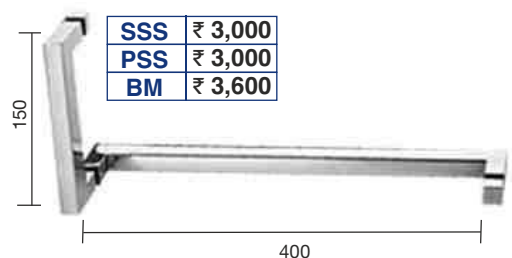

TGH-TB-ED
Towel Bar with Handle (20x20mm)

SSS	₹ 3,000
PSS	₹ 3,000
BM	₹ 3,600

SHOWER FITTINGS



MATERIAL: SS 304

DOOR KNOBS

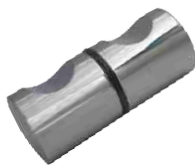

CP	₹ 660
BM	₹ 700
GP	₹ 750
RGP	₹ 780

TDK-1
Glass Door Knob



CP	₹ 660
BM	₹ 700
GP	₹ 750
RGP	₹ 780

TDK-2
Glass Door Knob

SHOWER KNIGHT HEAD ACCESSORIES



SSS	₹ 600
PSS	₹ 600
BM	₹ 800
GP	₹ 1,000
RGP	₹ 1,050

TSKH-1
Reinforcing Rod
With Wall Connector



SSS	₹ 670
PSS	₹ 670
BM	₹ 850
GP	₹ 1,100
RGP	₹ 1,150

TSKH-2
Reinforcing Rod Support
from Glass Through and Through



SSS	₹ 680
PSS	₹ 680
BM	₹ 900
GP	₹ 1,150
RGP	₹ 1,200

TSKH-2A
Reinforcing Rod Support from
Glass One Side Blind



SSS	₹ 1,000
PSS	₹ 1,000
BM	₹ 1,300
GP	₹ 1,600
RGP	₹ 1,700

TSKH-3
Reinforcing Rod Connector Universal



SSS	₹ 950
PSS	₹ 950
BM	₹ 1,200
GP	₹ 1,500
RGP	₹ 1,570

TSKH-4
Rod to Rod 'T' Connector

	1.6Mtr	2Mtr	3Mtr
SSS	₹ 1,400	₹ 1,700	₹ 2,500
PSS	₹ 1,750	₹ 2,000	₹ 2,900
BM	₹ 2,800	₹ 3,500	₹ 4,000
GP	₹ 3,050	₹ 3,800	₹ 5,200
RGP	₹ 3,500	₹ 4,000	₹ 5,500

TSKH-ACC-19
Reinforcing Rod 19 mm Diameter
(Available in 1.6mtr, 2mtr & 3mtr)

EDGE LINE KNIGHT HEAD ACCESSORIES



PSS	₹ 600
BM	₹ 700
GP	₹ 800
RGP	₹ 850

TSSKH-1-ED
Wall to Track Connector



PSS	₹ 680
BM	₹ 800
GP	₹ 900
RGP	₹ 950

TSSKH-2-ED
Track to Glass Connector



PSS	₹ 980
BM	₹ 1,200
GP	₹ 1,350
RGP	₹ 1,450

TSSKH-3-ED
Glass to Track end Connector
Track to Track 90° Connector



TSL-11-TRACK
Track Available in
1.6mtr, 2mtr & 3mtr

	1.6Mtr	2Mtr	3Mtr
SSS	₹ 2,200	₹ 2,700	₹ 4,300
PSS	₹ 2,400	₹ 2,800	₹ 4,300
BM	₹ 3,500	₹ 3,300	₹ 5,000
GP	₹ 3,900	₹ 4,000	₹ 6,000
RGP	₹ 4,100	₹ 4,200	₹ 6,500

PLASTIC PROFILES

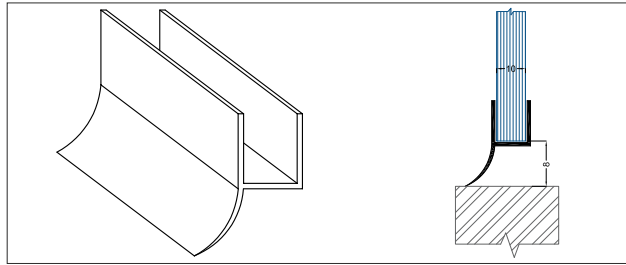

TPS-1
Wall Seal

PVC	₹ 280
BM	₹ 310
GM	₹ 450
RGM	₹ 500

TPS-1 (8FEET)-PVC ₹ 320

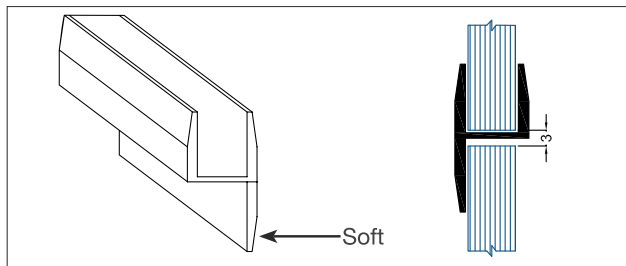

TPS-3 (Soft)
Central 180°
Weather Seal

PVC	₹ 280
BM	₹ 310
GM	₹ 450
RGM	₹ 500

TPS-3(Soft) (8FEET)-PVC ₹ 320

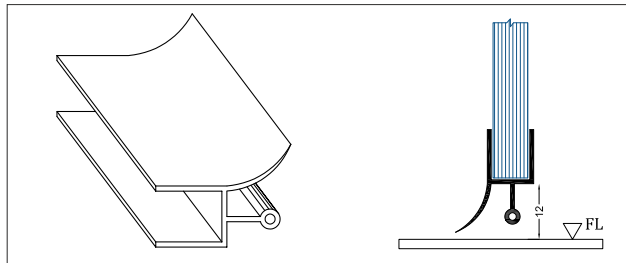

TPS-7
Water Dispersal Seal

PVC	₹ 280
BM	₹ 310

TPS-7 (8FEET)-PVC ₹ 320

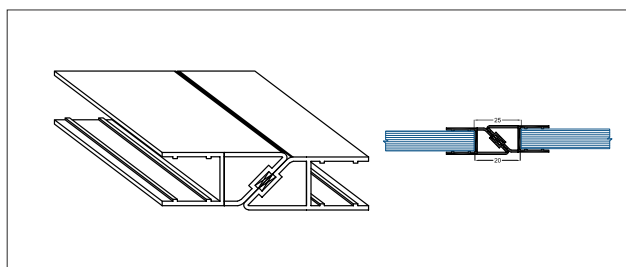

TPS-M1
180° Magnetic Seal

PVC	₹ 1,100
BM	₹ 1,200
GP	₹ 1,450
RGP	₹ 1,500

TPS-M1 (8FEET)

PVC	₹ 1,350
BM	₹ 1,450

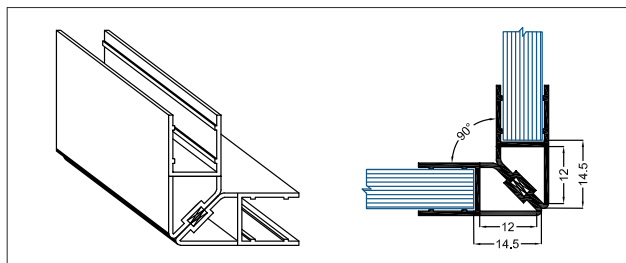

TPS-M3-PVC ₹ 1,100
90° Magnetic Seal

PVC BM

Available for 8, 10 & 12mm Glass
Standard Length: 2.2mtr & 2.4mtr

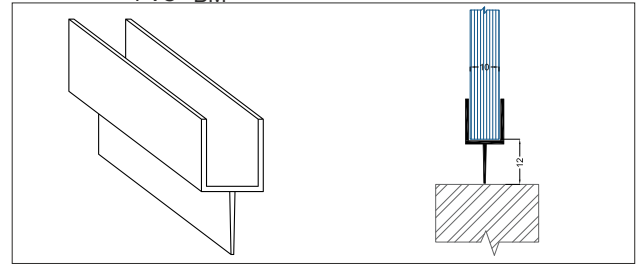

TPS-2-PVC ₹ 280
Central Seal

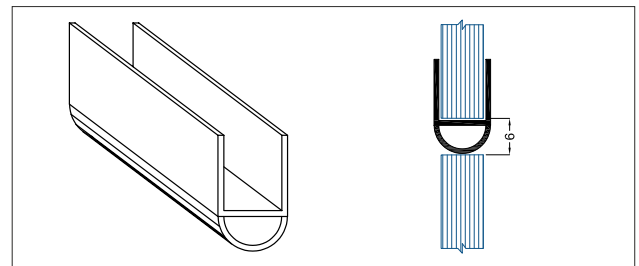

TPS-4
Central 180°
Weather Seal

PVC	₹ 280
BM	₹ 310
GM	₹ 450
RGM	₹ 500

TPS-4 (8FEET)-PVC ₹ 320

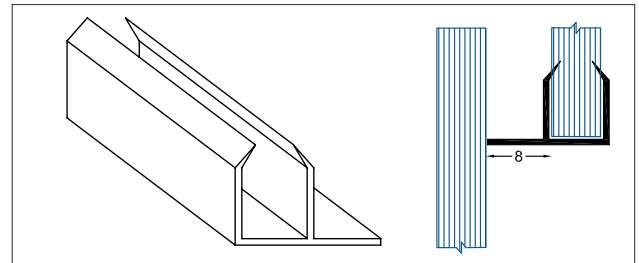

TPS-9
Offset Lip Seal

PVC	₹ 280
BM	₹ 310

TPS-9 (8FEET)-PVC ₹ 320

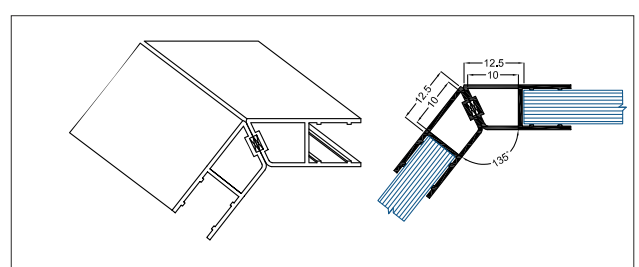

TPS-M2-PVC ₹ 1,100
135° Magnetic Seal

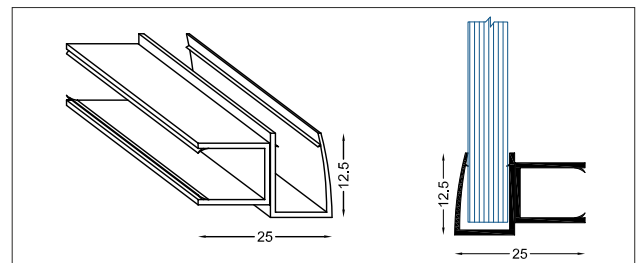

TPS-SL-BR-11-PVC ₹ 820
Brush Seal (Sliding Door)

TPS-SL-BR-11 12MM
8FEET ₹ 900
9FEET ₹ 1,000

ECONOMY SLIDING SHOWER SCREEN



ECONOMY SLIDING SHOWER SCREEN



(BM, GP and RGP available on demand)



TESL-SS-KIT ₹ 4,000
Single Door Sliding System wheel kit



TESL-SS-90-CNTR ₹ 1,200
90° Connector



TESL-SS-180-TRACK
(Available in 1.6mtr, 2mtr & 3mt)
Single Door



1.6Mtr ₹ 4,500
2Mtr ₹ 5,600
3Mtr ₹ 8,400
Double Door 90°

SPECIFICATIONS:

- Maximum Door Weight: 55kg
- Maximum Door Height: 2100mm
- Maximum Door Width: 800mm
- Suitable Glass Thickness: 8 & 10mm

COMPONENT DETAILS

PART LIST		SINGLE DOOR	DOUBLE DOOR 90°
	Aluminium Top Track Finish: Chrome	2 & 3mtr Length	1.65 mtr - 2 Length
	Track Corner Joint Finish: Chrome (for Corner Entry System)	N.A.	1 pc.
	Ø35 Stainless Steel Knob Clamp Roller Finish: Polished or Satin Stainless Steel *Suits 8-10mm Glass Thickness	2 pcs.	4 pcs.
	Nylon End Stopper	2 pcs.	4 pcs.
	Stainless Steel Mounting Bracket (LH/RH) Finish: Polished Stainless Steel	1 Set (1 LH & 1 RH)	1 Set (1 LH & 1 RH)
	Single-U Nylon Floor Guide	1 pc.	2 pcs.

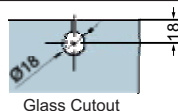

OPTIONAL ACCESSORIES



TGL-UPR
Al. U Channel
19 x 25 x 2400mm



TSL-HN-50
Sliding Door Handle



TSL-WPB 2 Mtr ₹ 5,800
Water Proof Bars
50x60x2000mm

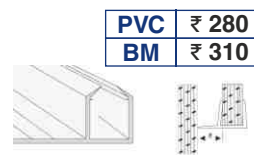

TPS-9
Offset Lip Seal



TGC-4
Wall to Glass Connector 90°

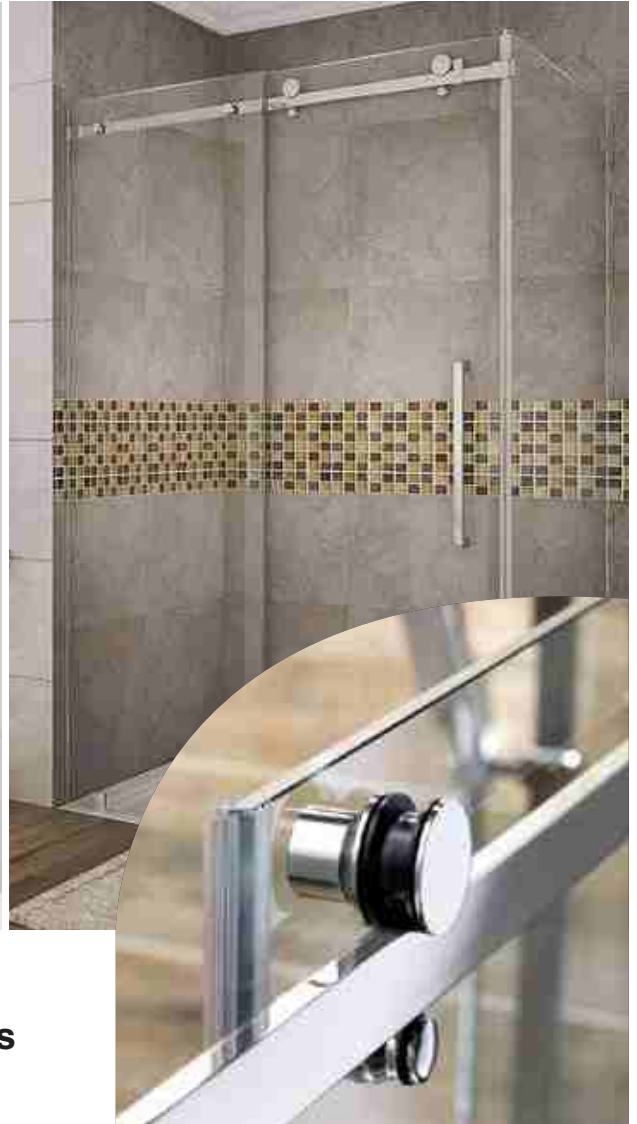

**SLIDING DOOR SYSTEM-11
for Shower Cubicles & internal Applications**

TSL-11-KIT

System consists of:

- Rollers 2 sets
- Track to Glass Holder 2 pcs
- Stopper 2 pcs
- Floor Guide 1 pc
- Wall to Track Connector 2 pcs
- Sliding Door Handle (TSL-HN-50) 1 Pc
- Track to be ordered separately as per requirement

PSS	₹ 13,000
BM	₹ 17,000
GP	₹ 20,000
RGP	₹ 21,000

Suitable for 8mm-10mm Glass

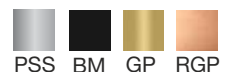

TSL-11-A1 ₹ 4,900/set
Sliding Door Roller Set



TSL-11-A2
Track to Glass Holder

PSS	₹ 1,900/set
BM	₹ 1,900/set
GP	₹ 2,100/set
RGP	₹ 2,100/set



TSL-11-A3 ₹ 1,200/PC
Stopper



TSL-11-A4 ₹ 1,800/PC
Floor Guide



TSSKH-1-ED
Wall to Track Connector

PSS	₹ 600
BM	₹ 700
GP	₹ 800
RGP	₹ 850



TSL-HN-50
Sliding Door Handle

SSS	₹ 1,550
BM	₹ 1,750
GP	₹ 1,950
RGP	₹ 2,100



TSL-11-TRACK
Track Available in 1.6mtr, 2mtr & 3mtr length



TSL-11-A6 ₹ 1,650/PC
Track to Glass Holder
Optional for 90° Application

SLIDING DOOR SYSTEMS



STANDARD SLIDING SYSTEM FOR WOODEN / FRAMED DOORS



TSL-WD-100 ₹ 1,800
Sliding System Set for Single Framed / Wooden Door of 100 Kg

2Mtr	SILVER	₹ 2,000
	BM	₹ 2,400
3Mtr	SILVER	₹ 3,000
	BM	₹ 3,600
4Mtr	SILVER	₹ 4,000
	BM	₹ 4,800



TSL-TRACK-E2
Top Track Suitable for TSL-WD-100 & TSL-WD-001 (Available in 2mt,3mt & 4mt)

STANDARD SLIDING SYSTEM FOR FRAMELESS GLASS DOORS



TSL-GL-120 ₹ 3,000
Sliding System for Single Frameless Glass Door of 120kg



TSL-TRACK-E2
Top Track Suitable for TSL-GL-120 (Available in 2mt,3mt & 4mt)

SOFT CLOSE SLIDING DOOR SYSTEM 44



- Soft Closing on Both Side
- High Speed Precise Bearings
- Material: Super Aluminum Alloy
- Minimum Door Width: 700mm

TSL-44-A1-SC KIT-1 ₹ 7,200
Single Buffer Damping Roller for Glass Door of 40kg

TSL-44-A1-SC KIT-2 ₹ 8,000
Double Buffer Damping Roller for Glass Door of 40kg

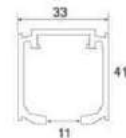

2Mtr	₹ 3,500
3Mtr	₹ 5,250
4Mtr	₹ 7,000
6Mtr	₹ 10,500

TSL-44-B1-SC TRACK
Soft Close Track Suitable for TSL-44-A1-SC (Available in 2mt,3mt & 4mt) (Only door)

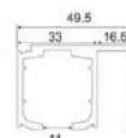

2Mtr	₹ 5,200
3Mtr	₹ 7,800
4Mtr	₹ 10,400
6Mtr	₹ 15,600

TSL-44-B3-SC TRACK
Soft Close Track Suitable for TSL-44-A1-SC (Available in 2mt,3mt & 4mt) (Door & fixed glass)

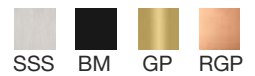
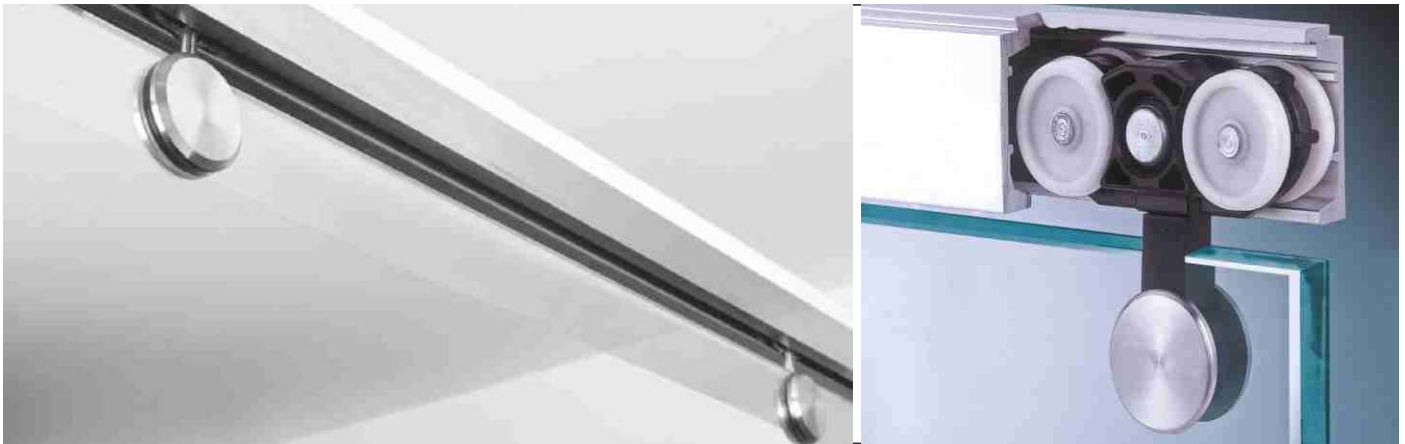

SLIDING DOOR SYSTEM-44



TSL-44-A1 KIT

System consists of

- Rollers 2pcs (Door weight upto 40kg)
- Stopper 2pcs
- Floor Guide 1Pc

(Available in Plastic and Metal Body)

SSS	₹ 3,900
BM	₹ 4,200
GP	₹ 4,500
RGP	₹ 4,800

METAL ₹ 4,900



TSL-44-A2 KIT

System consists of

- Rollers 2pcs (Door weight upto 80kg)
- Stopper 2pcs
- Floor Guide 1Pc

(Available in Metal Body Only)

SSS	₹ 5,900
BM	₹ 6,500
GP	₹ 7,000
RGP	₹ 7,500



SSS	₹ 650
BM	₹ 780

TSL-44-A5

Wall to Track Fixer



TSL-44-A9 ₹ 290

Wall to Track Fixer



SSS	₹ 1,800
BM	₹ 2,150

TSL-HN-10

Sliding Door Handle



SSS	₹ 1,550
BM	₹ 1,750
GP	₹ 1,950
RGP	₹ 2,100

TSL-HN-50

Sliding Door Handle



TSL-44-B1 Track

Aluminium Anodized Track (Only Door)

2Mtr	SILVER	₹ 3,800
	BM	₹ 4,600
	GM	₹ 5,700
	RGM	₹ 6,100
3Mtr	SILVER	₹ 5,700
	BM	₹ 6,900
	GM	₹ 8,500
	RGM	₹ 9,150
4Mtr	SILVER	₹ 7,600
	BM	₹ 9,200
	GM	₹ 11,400
	RGM	₹ 12,200

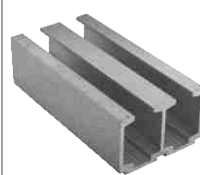

TSL-44-B2 Track

Aluminium Anodized Track (Double Door)

2Mtr	SILVER	₹ 5,000
	BM	₹ 6,000
	GM	₹ 7,500
	RGM	₹ 8,000
3Mtr	SILVER	₹ 7,500
	BM	₹ 9,000
	GM	₹ 11,250
	RGM	₹ 12,000
4Mtr	SILVER	₹ 10,000
	BM	₹ 12,000
	GM	₹ 15,000
	RGM	₹ 16,000



TSL-44-B3 Track

Aluminium Anodized Track (Door & Fixed Glass)

2Mtr	SILVER	₹ 4,200
	BM	₹ 5,000
	GM	₹ 6,300
	RGM	₹ 6,700
3Mtr	SILVER	₹ 6,300
	BM	₹ 7,500
	GM	₹ 9,450
	RGM	₹ 10,050
4Mtr	SILVER	₹ 8,400
	BM	₹ 10,000
	GM	₹ 12,600
	RGM	₹ 13,400
5Mtr	SILVER	₹ 10,500
	BM	₹ 12,500
	GM	₹ 15,750
	RGM	₹ 16,750

* 60 months warranty



SLIDING FOLDING SYSTEM-TSFS



TSFS-E1 ₹ 4,700
End Panel Fitting with Top Pivot



TSFS-E2 ₹ 4,500
End Panel Fitting with Bottom Pivot



TSFS-E3 ₹ 8,900
Glass to Glass Connecting Hinge with Floor Lock



TSFS-E4 ₹ 6,400
Glass to Glass Interconnecting Hinge



TSFS-E5 ₹ 7,500
Glass to Glass Connector With Roller



TSFS-E6 ₹ 7,200
Glass to Glass Connecting Hinge with Guide Locator



TSFS-E7 ₹ 5,000
End Sliding Folding Panel Fitting with Roller



TSFS-E8 ₹ 4,800
End Sliding Folding Panel Fitting with Guide Locator



TSFS-E9 ₹ 4,800
End Panel Fitting with Bottom Pivot (for odd panels)



TSFS-E10 ₹ 4,000
Wall to Glass Hinge



TSFS-C2 3/4/5Mtr ₹ 4,000/mtr
TSFS-C3 3/4/5Mtr ₹ 2,500/mtr
Top Track / Bottom Track 3mtr & 4mtr



TSSPL-SDL-G ₹ 13,500
TSSPL-SDL ₹ 10,000
Sliding Door Lock With Claw Type Dead Bolt & Strike Box/Plate

Panel Qty.	E1 & E2	E3 & E4	E5 & E6	E7 & E8	E9
2 Panels	01 Set	01 Set	-	01 Set	-
3 Panels	01 Set	01 Set	01 Set	-	01 Pc
4 Panels	01 Set	02 Sets	01 Set	01 Set	-
5 Panels	01 Set	02 Sets	02 Sets	-	01 Pc
6 Panels	01 Set	03 Sets	02 Sets	01 Set	-

WOODEN SLIDING FOLDING SYSTEM-TWSF



TWSF-01 ₹ 8,400



TWSF-02 ₹ 7,550



TWSF-03 ₹ 16,000



TWSF-04 ₹ 12,500



TWSF-05 ₹ 2,950



TWSF-011 ₹ 4,550/mtr



TWSF-043 ₹ 2,500/mtr



TWSL-ACC-22 ₹ 2,400

SPECIFICATIONS:

- Max panel height: 3300mm
- Max panel weight: 75kg.
- Max panel width: 900mm
- Suitable panel thk: 35 - 50mm

Panel Qty.	TWSF-01	TWSF-02	TWSF-03	TWSF-04
2 Panels	01 Set	01 Set	-	01 Set
3 Panels	01 Set	01 Set	01 Set	-
4 Panels	01 Set	02 Set	01 Set	01 Set
5 Panels	01 Set	02 Set	02 Set	-
6 Panels	01 Set	03 Set	02 Set	01 Set
8 Panels	01 Set	04 Set	03 Set	01 Set

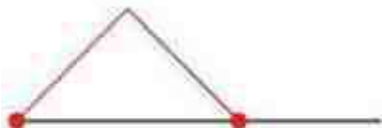

2 Panels

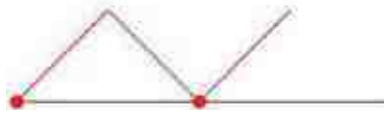

3 Panels



4 Panels



5 Panels



6 Panels



8 Panels



SPIDER FITTINGS

Spider systems are used to create spaces with minimal visual weight. Spider fittings are designed for mounting glass to walls, posts or other structural substrates with minimal visible connections. Manufactured from stainless steel 316 grade and 304 grade, available in two finishes : Satin Stainless Steel and Polished Stainless Steel, Spider Fittings Support the four glass corners and keep the glass panels leveled, can be placed within the building, with only a small flushed screw on outside which results in completely smooth outer view.



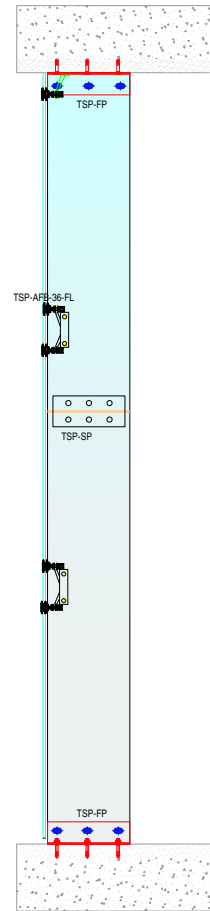
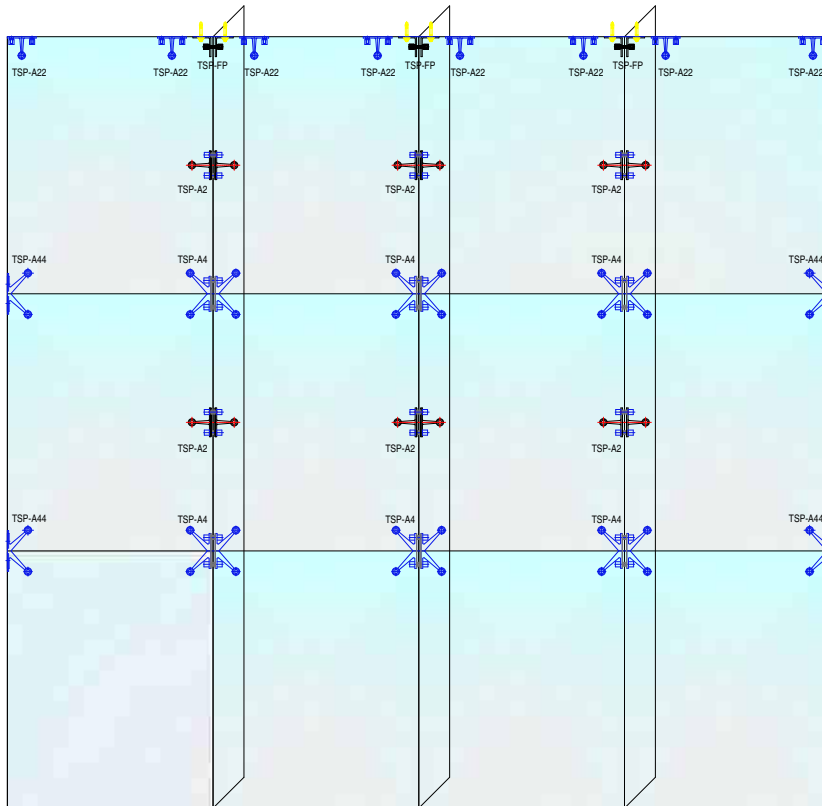

SPIDER FITTINGS WITH FIN

SS 316

Finish: SSS (PSS available on demand)

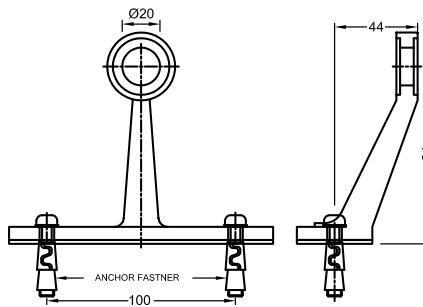

Specifications:

- Installed with routels
- Teflon washers prevent glass damage
- For ceiling/wall to glass installation
- Supplied with Anchor Fasteners

TSP-A22
One Way Spider for Ceiling/Wall

SSS	₹ 2,600
PSS	₹ 3,300

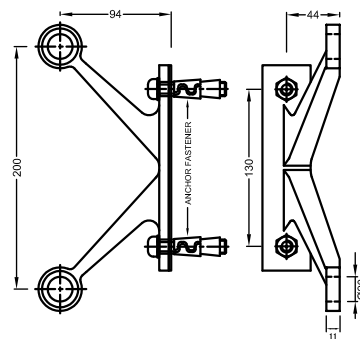

Specifications:

- Installed with routels
- Teflon washers prevent glass damage
- For ceiling/wall to glass installation
- Supplied with Anchor Fasteners

TSP-A44
Two Way Spider for Ceiling/Wall

SSS	₹ 3,000
PSS	₹ 3,800

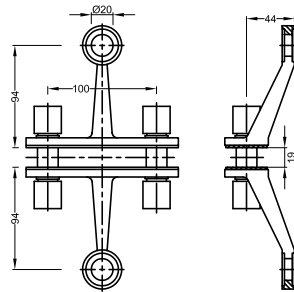
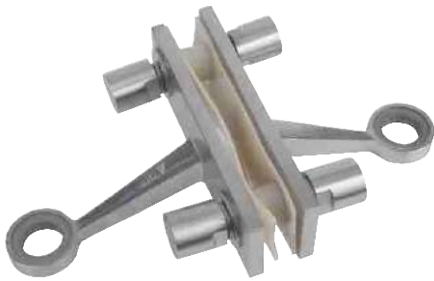

Specifications:

- Installed with routels
- Teflon washers prevent glass damage
- Firm holding with fin

SSS	₹ 5,200
PSS	₹ 6,200

TSP-A2
Two Way Spider with Fin

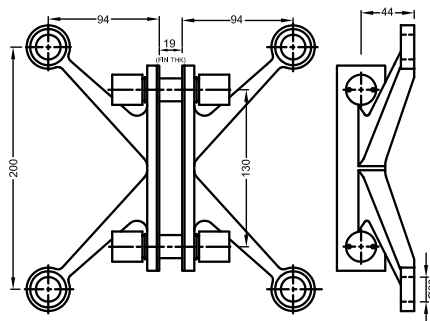
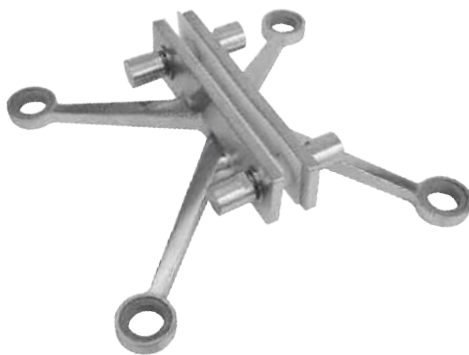

Specifications:

- Installed with routels
- Teflon washers prevent glass damage
- Firm holding with fin

SSS	₹ 6,000
PSS	₹ 7,000

TSP-A4
Four Way Spider with Fin

Fin thickness is suggestive

Dimensions are subject to change. Kindly refer to actual products for glass preparation

SPIDER FITTINGS WITHOUT FIN (200MM ARM DISTANCE)

SS 316

Finish: SSS (PSS available on demand)

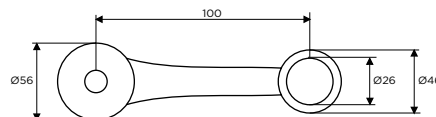

TSP-B-201	₹ 2,600
------------------	---------

One Way Spider without Fin

Specifications:

- 145mm Arm
- Attached to a fixed structure
- Installed with routels

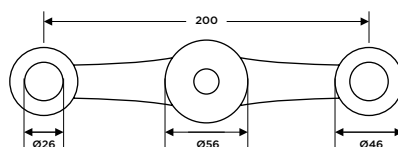

TSP-B-202	₹ 3,600
------------------	---------

Two Way Spider without Fin 180°

Specifications:

- 200mm Arm
- Attached to a fixed structure
- Installed with routels



TSP-B-202A ₹ 4,000

Two Way Spider without Fin 90°

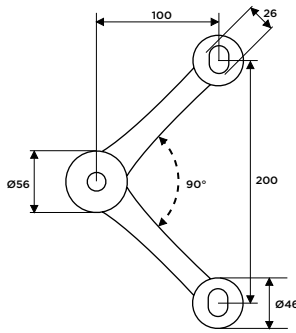

Specifications:

- 200mm Arm
- Attached to a fixed structure
- Installed with routels



TSP-B-203 ₹ 5,000

Three Way Spider without Fin

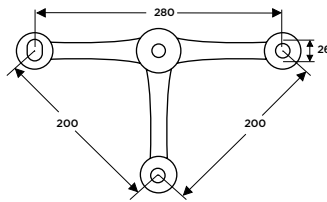

Specifications:

- 200mm Arm
- Attached to a fixed structure
- Installed with routels



TSP-B-204 ₹ 5,400

Four Way Spider without Fin

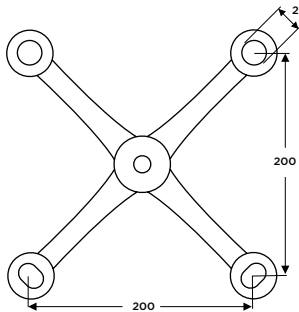

Specifications:

- 200mm Arm
- Attached to a fixed structure
- Installed with routels

SPIDER FITTINGS WITHOUT FIN (220MM ARM DISTANCE)

SS 316

Finish: SSS (PSS available on demand)



TSP-B-221 ₹ 3,200

One Way Spider without Fin

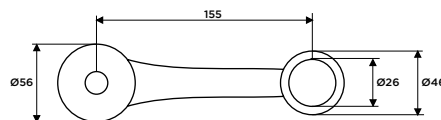

Specifications:

- 155mm Arm
- Attached to a fixed structure
- Installed with routels



TSP-B-222 ₹ 4,100

Two Way Spider without Fin 180°

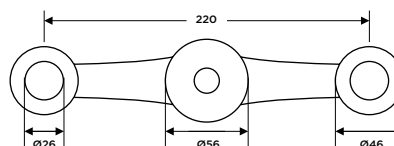

Specifications:

- 220mm Arm
- Attached to a fixed structure
- Installed with routels

SPIDER FITTINGS



TSP-B-222A ₹ 4,800

Two Way Spider without Fin 90°

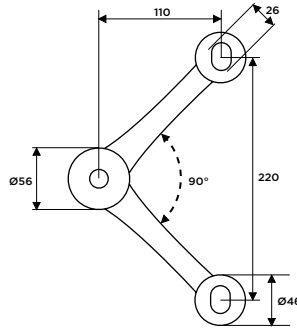

Specifications:

- 220mm Arm
- Attached to a fixed structure
- Installed with routels



TSP-B-223 ₹ 5,800

Three Way Spider without Fin

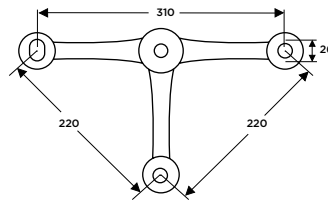

Specifications:

- 220mm Arm
- Attached to a fixed structure
- Installed with routels



TSP-B-224 ₹ 6,200

Four Way Spider without Fin

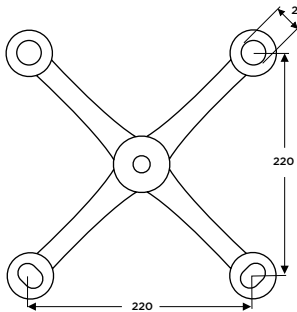

Specifications:

- 220mm Arm
- Attached to a fixed structure
- Installed with routels

SPLICE PLATES



TSP-SP-200 ₹ 7,500

Splice Plate 200mm



TSP-SP-300 ₹ 9,500

Splice Plate 300mm



TSP-SP-350

Splice Plate 350mm
(400 & 450mm also available)

350mm	₹ 11,500
400mm	₹ 13,500
450mm	₹ 15,500

SS 304

Finish: SSS (PSS available on demand)

FIN PLATES



TSP-FP-200 ₹ 9,000

Fin Plate 200mm



TSP-FP-300 ₹ 10,000

Fin Plate 300mm



TSP-FP-350

Fin Plate 350mm
(400 & 450mm also available)

350mm	₹ 11,000
400mm	₹ 13,000
450mm	₹ 16,000

SS 304

Finish: SSS (PSS available on demand)

SPIDER BOLTS

SS 316

Finish: SSS (PSS available on demand)



SSS	₹ 1,100
PSS	₹ 1,400

TSP-FB-FL
Fixed Bolt (Flat Head)



SSS	₹ 2,000
PSS	₹ 2,400

TSP-AFB-36-FL
Articulate Bolt (Flat head)



TSP-SH-01 ₹ 1,600
To Hold Without Fin
Spiders to any Structure

GLASS CANOPY FITTINGS

SS 304

Finish: SSS (PSS available on demand)



TCF-01 ₹ 6,800
Wall to Glass Connector



TCF-02 ₹ 7,200
Adjustable Glass Connector
for TCF-316



TCF-03 ₹ 6,200
Wall Fitting for TCF-316



TCF-316 ₹ 11,500
Threaded Sleeve for
TCF-ROD (Supplied In Pairs)



12mm	₹ 2,400/mtr
16mm	₹ 2,600/mtr

TCF-ROD-12mm/16mm
Rod 12mm for TCF-02S & 03S
Rod 16mm for TCF-316



TCF-01-S ₹ 2,600
Wall to Glass Connector



TCF-02-S ₹ 2,400
Glass Fitting for
TCF-ROD-12mm



TCF-03-S ₹ 1,700
Wall Fittings for
TCF-ROD-12mm

DOOR CONTROL HARDWARE

TAITON features innovative collection of Wooden/metal door fittings. Every fitting is designed to meet the modern design aesthetic requirements apart from the functional performance.

Manufactured from high quality materials, wide range of fittings are available in different finishes to select from to suit your needs.



LUXURY DOOR HANDLES

Brass



TMH- LX-B1

Finish: Copper, Antique, Satin, Rose Gold.

COPPER	₹ 5,800	SATIN	₹ 5,800
BM	₹ 5,800	R.GOLD	₹ 7,700



TMH- LX-B2

Finish: Copper, Antique, Satin, Rose Gold.

COPPER	₹ 5,300	SATIN	₹ 5,300
BM	₹ 5,300	R.GOLD	₹ 6,900



TMH- LX-B3

Finish: Copper, Antique, Satin, Rose Gold.

COPPER	₹ 5,800	SATIN	₹ 5,800
BM	₹ 5,800	R.GOLD	₹ 7,400



TMH- LX-B4

Finish: Copper, Antique, Satin, Rose Gold.

COPPER	₹ 5,800	SATIN	₹ 5,800
BM	₹ 5,800	R.GOLD	₹ 7,700



TMH- LX-B5

Finish: Copper, Antique, Satin, Rose Gold.

COPPER	₹ 5,800	SATIN	₹ 5,800
BM	₹ 5,800	R.GOLD	₹ 7,700



TMH- LX-B6

Finish: Copper, Antique, Satin, Rose Gold.

COPPER	₹ 5,800	SATIN	₹ 5,800
BM	₹ 5,800	R.GOLD	₹ 6,900



TMH- LX-B7

Finish: Copper, Antique, Satin, Rose Gold.

COPPER	₹ 5,700	SATIN	₹ 5,700
BM	₹ 5,700	R.GOLD	₹ 7,600



TMH- LX-B8

Finish: Copper, Antique, Satin, Rose Gold.

COPPER	₹ 5,800	SATIN	₹ 5,800
BM	₹ 5,800	R.GOLD	₹ 7,700



TMH- LX-B9

Finish: Copper, Antique, Satin, Rose Gold.

COPPER	₹ 6,700	SATIN	₹ 6,700
BM	₹ 6,700	R.GOLD	₹ 8,600

DOOR HANDLES, MORTISE LOCK BODY & EP CYLINDER



DOOR HANDLES



TMH-11
D-Type Mortise Handle



TMH-22
Tubular Mortise Handle



TMH-33
Tubular Mortise Handle



TMH-33N
Tubular Mortise Handle for
Narrow Style Doors

MORTISE LOCK BODY

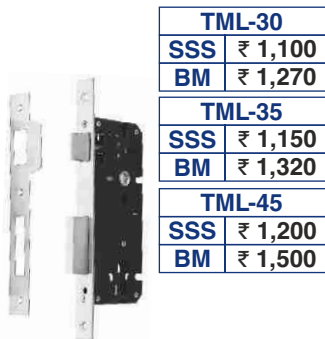

TML-30 (30x85mm)
TML-35 (35x85mm)
TML-45 (45x85mm)
Lock Body for Wooden Doors
with Latch & Dead Bolt

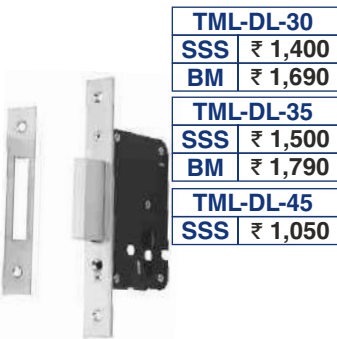

TML-DL-30mm
TML-DL-35mm
TML-DL-45mm
Dead Lock for
Steel/Wooden Door



TML-L-43mm ₹ 580
Latch Bolt for
Steel/Wooden Door



TML-20 (20x85mm)
Narrow Style Lock Body for
Al./Wooden Doors with
Latch & Dead Bolt

EURO PROFILE CYLINDERS



TML-HL-20mm ₹ 1,450
Hook Lock for
Steel/Wooden Door



TMC-22-K2K-N
Both Side keys
(Available in 60/70/80mm)



TMC-22-K2N-N
One Side key & One Side Knob
(Available in 60/70/80mm)



TMC-22-BT-N
One Side Knob & Other Side
Coin Release

HALF CYLINDERS



TMC-22-HC-K-45 ₹ 750
Half Cylinder with 3 Keys



TMC-22-HC-N-45 ₹ 800
Half Cylinder with Knob

CYLINDRICAL KNOB LOCKS



TCKL-11 ₹ 1,000
Knob Lock with Key Operation
& Push Button



TCKL-22 ₹ 900
Knob Lock with Push Button &
Coin Release

AUTO DROP DOWN DOOR SEAL

TA-DWDS **900MM ₹ 2,700**
1000MM ₹ 2,800

Features:

- Available in 900mm & 1000mm
- Unilateral Sealing
- Max. Sealing Height: 12mm
- Slotting Width: 15mm
- Shell Material: Aluminium
- Strip: PVC

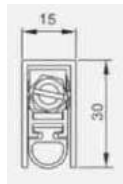

INDICATOR ESCUTCHEON



TIL-RA ₹ 1,150
Indicator with Knob



TML-IL ₹ 850
Indicator Lock Body



TIL-RB ₹ 1,300
Indicator with Turn Latch Bolt

SS BUTT HINGES



TA-BH-4BB 5x3x3 ₹ 540
Four Ball Bearings

SS 304



TA-BH-4BB 4x3x3 ₹ 460
Four Ball Bearings



TA-BH-NBB 5x2.5x2.5 ₹ 170
Without Ball Bearings

SS 202



TA-BH-NBB 4x2.5x2.5 ₹ 130
Without Ball Bearings

DOOR ACCESSORIES



SSS ₹ 1,000

TA-BH-SC 5x3x3
Soft Closing Hinges



SSS ₹ 800

TA-BH-SC 4x3x3
Soft Closing Hinges



SSS ₹ 700

TA-DE-1
Door Viewer



SSS ₹ 950

TA-DC-1
Door Chain



SSS ₹ 1,100

TA-DG-1
Door Guard



SSS ₹ 900
BM ₹ 1,000

TA-CFB-300
Concealed Flush Bolt



SSS ₹ 200
BM ₹ 240

TA-DST-1
Door Stopper



TA-DB-1 ₹ 120
Door Buffer-PVC White 3"



TA-DST-4M ₹ 1,200
Magnetic Door Stopper



TA-DST-2 ₹ 285
Door Mounted Hanging Type Stopper



STANDARD TYPE		
	SS304	SS202
TA-TB-4"	₹ 235	₹ 140
TA-TB-6"	₹ 360	₹ 210
TA-TB-8"	₹ 490	₹ 300
TA-TB-10"	₹ 610	₹ 370
TA-TB-12"	₹ 740	₹ 430
TA-TB-18"	₹ 1,300	₹ 840



SINGLE CYLINDER FLOOR SPRING

SSS ₹ 3,800



TFS-5400-TP/BP

Single Cylinder Floor Spring for Wood/Aluminium Door with Accessories (Maximum Door Weight Upto 60Kg)

SSS ₹ 6,000
BM ₹ 6,800



TFS-6000-GD

Single Cylinder Floor Spring for Glass Door with Top & Bottom Patch (Maximum Door Weight Upto 70Kg)

SSS ₹ 4,200
BM ₹ 5,000
GP ₹ 6,000
RGP ₹ 7,000



TFS-6400

Single Cylinder Floor Spring for Wood/Aluminium/Glass Door (Maximum Door Weight Upto 80Kg)

DOUBLE CYLINDER FLOOR SPRING

SSS ₹ 15,000



TFS-RV-8400

Single Cylinder 360 Revolving Floor Spring (Max Door Weight Upto 85Kg) 5,00,000 Cycle Tested

SSS ₹ 8,200
BM ₹ 9,200
GP ₹ 11,000
RGP ₹ 12,000



TFS-8400

Double Cylinder Floor Spring (Max Door Weight Upto 100Kg) 5,00,000 Cycle Tested

SSS ₹ 9,000
BM ₹ 10,000
GP ₹ 12,000
RGP ₹ 13,000



TFS-9400

Double Cylinder Floor Spring (Max Door Weight Upto 150Kg) 5,00,000 Cycle Tested

SSS ₹ 15,200



TFS-10400

Double Cylinder Floor Spring (Max Door Weight Upto 300Kg) 5,00,000 Cycle Tested

ACCESSORIES FOR FLOOR SPRING

SSS ₹ 1,100

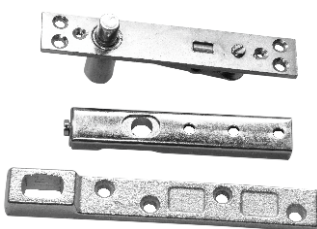

TFS-ACC-TP/BP

Top & Bottom Pivot for Wooden/Aluminium Door

SSS ₹ 1,250
BM ₹ 1,400



TFS-ACC-MH-1

Mini Floor Hinge Compatible with Patch Fittings

HYDRAULIC FLOOR HINGE

SSS ₹ 9,000
BM ₹ 10,000
GP ₹ 12,000
RGP ₹ 13,000



TCFH-100

Hydraulic Floor Hinge
• Max door Weight: Upto 100kg

SILVER
 BM

OVERHEAD DOOR CLOSER



TSK-60 ₹ 1,600

- With Standard Arm
- Maximum door weight: 60kg
- Maximum Door Width: 950mm
- 3,00,000 Cycles Tested



TSK-80 ₹ 2,700

- With Standard Arm
- Maximum door weight: 80kg
- Maximum Door Width: 1100mm
- 3,00,000 Cycles Tested



TSK-800 ₹ 4,000

- With Track Arm
- Maximum door weight: 80kg
- Maximum Door Width: 1100mm
- 3,00,000 Cycles Tested



TSK-900

SILVER ₹ 7,500
BM ₹ 8,000

- With Track Arm
- Maximum door weight: 80kg
- Maximum Door Width: 1200mm
- 5,00,000 Cycles Tested



CONCEALED DOOR CLOSER



TCD-3500 ₹ 5,000

- With Track Arm
- Maximum door weight: 60kg
- Maximum Door Width: 950mm
- Minimum Door Thickness for Installation: 35mm
- 3,00,000 Cycles Tested

ACCESSORY

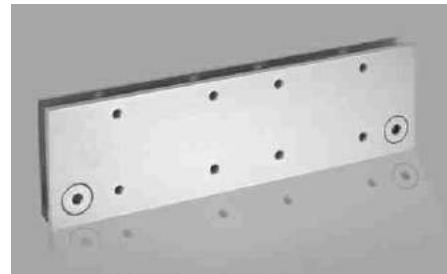

TSK-ACC-900-PLATE

SILVER ₹ 2,000
BM ₹ 2,450

- Plate for Mounting Door Closer on Glass

EXCLUSIVE LUXURY SHOWER CUBICLES

TAITON MAXIA features the next generation luxury shower cubicles which are crafted to give elegance and style to the bathroom.

TAITON MAXIA's luxurious range of shower cubicles takes the aesthetics of the bathroom to the next level. There is no better way to elevate your spirits to refresh and rejuvenate than taking bath in your customized TAITON MAXIA Shower Cubicle.

Glasses are supplied with blast resistant film which ensures that the glass is not scattered in the event of breakage.





TMAX-DS2501

Automatic Sliding Door Shower Cubicle

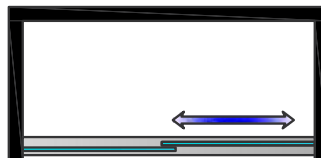

- One Fixed One Sliding Magic Smart Glass (Available without smart glass also)
- Driven by new generation magnetic levitation power, which is safe, stable & reliable
- System Automatically Rebound when meet resistance during closing
- Infrared Sensor Switch for Safe & Convenient Opening
- The voltage is controlled within 24 volts, allowing you to enjoy the shower without worry
- Standard size: 1500x2000mm (customization available on demand)
- Standard Glass Thickness: 10mm
- Standard color: Black Matte
- Material: SS 304



TMAX-S4102

Double Sliding Door Shower Cubicle

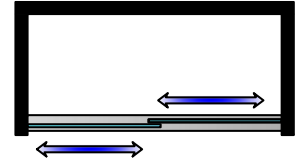

- Door opening can be done in dual direction, more humane.
- Roller Inclined plane design for noiseless operation and durability
- Innovative dust-removal track wheel design.
- Glass Crystal embedded frame, trendy and elegant.
- Integral buffering and wheel design reduces buffer noise and vibration, and reduces resistance
- Standard size: 1600x2000mm (customization available on demand)
- Standard glass thickness: 10mm
- Standard color: Rose Gold inlaid with Crystal
- Material: SS 304



TMAX-S8401

Sliding Door Shower Cubicle

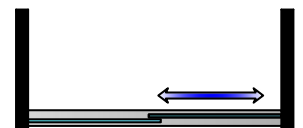

- Dustproof and quiet track design
- Beveled design of the pulley is quiet and durable
- Customized design hanging wheel and fixed towel bar
- Standard size: 1600x2000mm (customization available on demand)
- Standard glass thickness: 10mm
- Standard color: Black Matte
- Material : SS 304



TMAX-DL2C02

Double Sliding Door Shower Cubicle

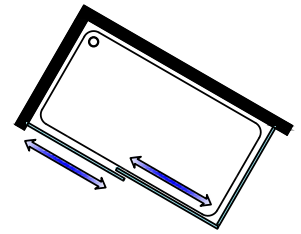

- Door opening can be done in dual direction, more humane
- Hollow square rounded corner hanging clips, stylish and luxurious
- Slim hollow long handle, can be used as a towel bar, sleek and simple
- Standard size : 1000x1400x2000mm (customization available on demand)
- Standard glass thickness : 10mm
- Standard color : Green Bronze
- Material : SS 304



TMAX-D5301

Swing Door Shower Cubicle

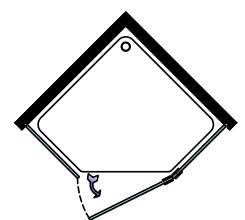

- 'Balance beam' structure design hinge in the middle to prevent hinge sinking
- Etch carving and rose color electroplating on all hardware
- Angle line combination design of handles
- Back water tank design at bottom of door to completely separate wet and dry areas.
- Standard size : 1000x1000x2000mm (customization available on demand)
- Standard glass thickness : 8/10mm
- Standard color : Green Bronze
- Material : SS 304



TMAX-D5601

Swing Door Shower Cubicle

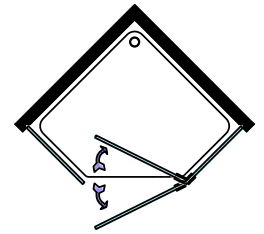

- Built-in hinge design, beautiful and not sinking
- The glass is simple and framed, with a strong Nordic style
- Door can be opened inside and outside as per requirement
- Standard size: 1000x1000x2000mm (customization available on demand)
- Standard glass thickness: 8mm
- Standard color: Black Matte
- Material : Original 6463 Aluminum profile



TMAX-S8302

Double Sliding Door Shower Cubicle

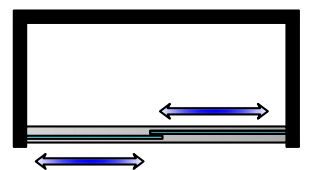

- Door opening can be done in dual direction, more humane
- Beveled pulley design, quiet and durable
- Innovative dustproof & silent track design
- Georgian bar design add a rich Nordic minimalist style
- Standard size: 1600x2000mm (customization available on demand)
- Standard glass thickness: 8mm
- Standard color: Black Matte
- Material: SS 304 Stainless Steel/6463 Aluminium Alloy



TMAX-S5851
Swing Door Shower Cubicle

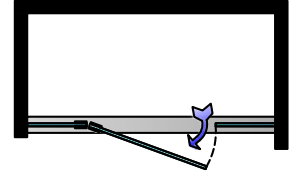

- The narrow all-inclusive design of the frame is simple and stylish
- L-Shaped long handle, parent-child design, suitable for both young and old
- The slender hinges echo the minimalist style
- Standard size : 1500x2000mm (customization available on demand)
- Standard glass thickness : 10mm
- Standard color : Clear Chrome/Black Matte
- Material : SS 304



TMAX-S5151E
Swing Door Shower Cubicle

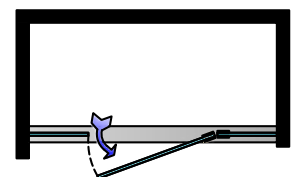

- Extremely simple product, with elegant framed design, with harmonious matching, high-class and clear
- Back water tank design at bottom of door to completely separate wet and dry areas
- Standard size: 1500x2000mm (customization available on demand)
- Standard glass thickness: 8/10mm
- Standard color: Black Matte
- Material : SS 304



TMAX-S4202

Double Sliding Door Shower Cubicle

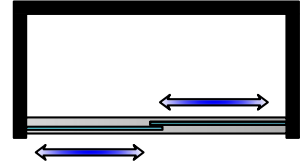

- Door opening can be done in dual direction, more humane
- Roller Inclined plane design for noiseless operation and durability
- Innovative dust-removal track wheel design
- Integral buffering and wheel design reduces buffer noise and vibration, and reduces resistance.
- Shell embedded Hanging wheel and handle, trendy and elegant
- Standard size : 1600x2000mm (customization available on demand)
- Standard glass thickness : 10mm
- Standard color : Clear Chrome
- Material : SS 304/8K



TMAX-S4002

Double Sliding Door Shower Cubicle

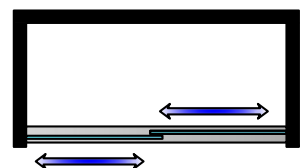

- Door opening can be done in dual direction, more humane
- Self lubricating totally closed bearing, super quiet sliding
- Glide block design, better for cleaning
- Track appearance design is unique and delicate, with concise and trendy textures
- Square round-angle design handle, safe and comfortable
- Standard size: 1600x2000mm (customization available on demand)
- Standard glass thickness: 8mm
- Standard color: Clear Chrome
- Material: SS 304/8K



TMAX- C 6902
Shower Cabinet with Fan Sliding Door



- Opening method: Shower Cabinet with Fan sliding door
- Standard size: 900x900x1900mm 1000x1000x1900mm
- Standard thickness of galss: 8mm super-strong all-tough ened safety galss
- Standard Color: Clear chrome

Non-standard specifications can be ordered



TMAX- L 9401
Outside Openable Door Shower Room



- Opening method: Rectangular Outside Openable Door Shower Room
- Standard Size: 800x1000x2000mm
- Standard Thickness of galss: 8/10mm super-strong all- toughened safety galss
- Standard Color: Green bronze

Non-standard specifications can be ordered



TMAX- D 5501

Diamond Outside Openable Door Shower Room



- Opening method: Diamond id outside Openable door shower room
- Standard size: 900x900x2000mm 1000x1000x2000mm
- Standard thickness of galss: 8/10mm super-strong all-tough ened safety galss
- Standard Color: Rose Gold in laid with galss

Non-standard specifications can be ordered



TMAX- S 5751

Two fixed one Drop Outside Openable Door Screen



- Opening method: Two Fixed One Drop Outside Openable Door Screen
- Standard size: (1200-1200)x2000mm
- Standard thickness of galss: 10mm super-strong all-tough ened safety galss
- Standard Color: Clear chrome,Matte black, Metallic gray

Non-standard specifications can be ordered

AUTOMATIC SLIDING DOORS

TAITON features Automatic Sliding Doors which are designed for ease and convenience, better aesthetics, secured door entry and above all savings due to thermal management. Automatic Sliding doors can be integrated with various accessories available to operate the door as per the site requirements.

TAITON also offers breakout doors which are highly recommended in emergency exit and escape route doors in Airports, Commercial spaces, hospitals and many other building types.

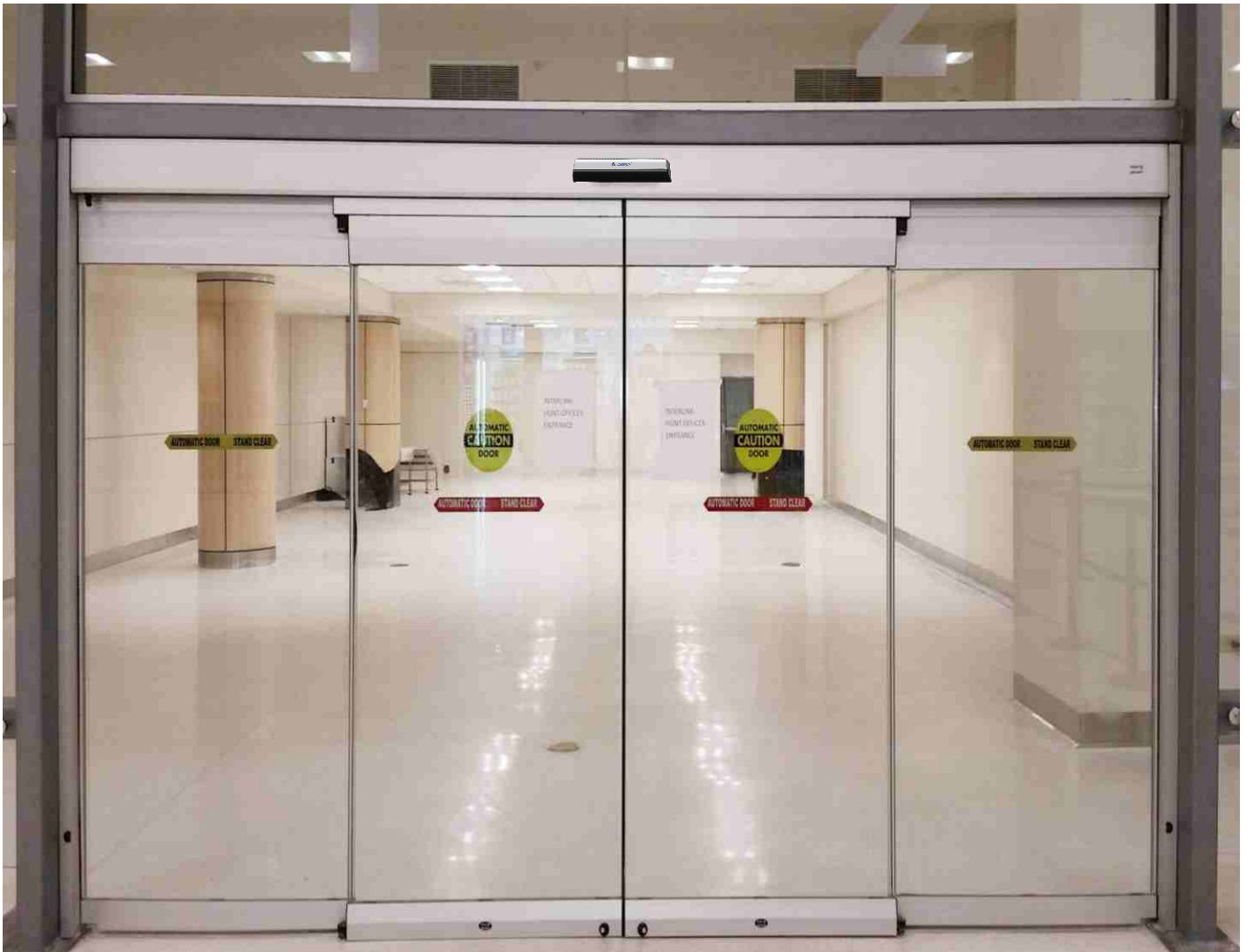

AUTOMATIC SLIDING DOORS



PREMIUM SLIDE

TAM-PS-01

Available in 4.2mtr & 6mtr Track Length

4.2mtr	₹ 1,60,000/set
6.0mtr	₹ 1,75,000/set

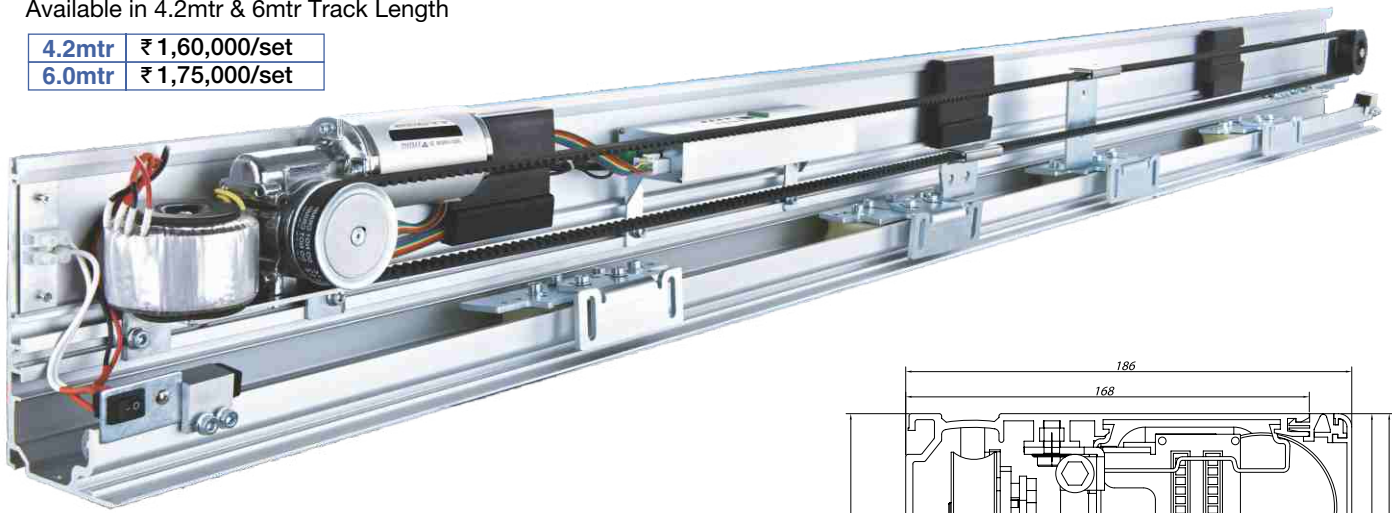

Modes of Operation

- Permanent Open
- Closed
- Automatic
- Partial Open
- Exit Only
- Off

Adjustable Parameters for:

- Opening Speed
- Door Buffer Distance
- Door Buffer Intensity
- Starting Force
- Opening Hours
- Closing Speed
- Closed Buffer Distance
- Closed Buffer Force

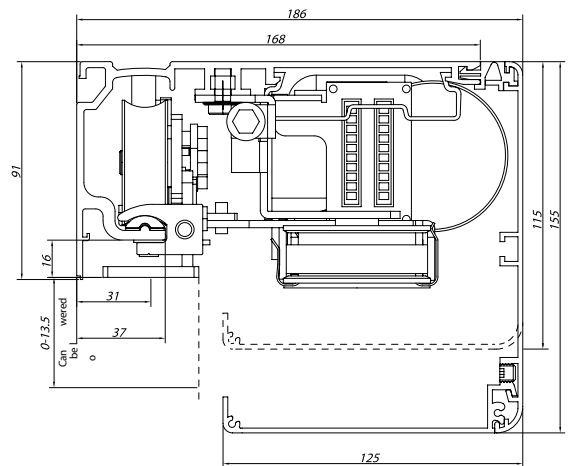

PART LIST

Specification			STANDARD			
TAM-PS-01 (4.2 Mtr/6 Mtr)			Product Code	Fitting	Quantity	MRP
Horizontal Pull	Single Door	Double Doors	TAM-PS-01 TRACK	Track	1 Pcs (4.2/6 Mtr)	₹ 38,000/ ₹ 63,000
Leaf Weight	<150Kg	<120kg x 2	TAM-PS-01-CNTR	Controller	1 Pcs	₹ 40,000
Width of Door	700-1500mm	600-1500mm	TAM-PS-01-MT	Motor	1 Pcs	₹ 40,000
Controller	High-Performance Digital Micro-Controller		TAM-PS-01-PS	Power Switch	1 Pcs	₹ 1,700
Motor	DC 24V 65W with Toroidal Transformer		TAM-TB	Toothed Belt	1 Pcs (8/12 Mtr)	₹ 750/mtr
Opening Speed	< 400mm / s (adjustable)		TAM-BC	Belt Connection	1 Set	₹ 1,200
Closing Speed	< 300mm / s (adjustable)		TAM-PS-01-RC	Remote Control	1 Pair	₹ 3,700
Door Hold Time	0.5 - 10s (adjustable)		TAM-PS-01-TW	Adjustable Tension Wheel	1 Pcs	₹ 3,500
Manual Thrust	< 45N		TAM-MS	Sensor	2 Pcs	₹ 8,200/pc
Opening Direction	Optional		TAM-PS-01-STPR	Stopper	1 Pcs	₹ 1,200
Supply Voltage	AC110V/AC220V 50/60Hz		TAM-PS-01-HGR	Hanger	4 Pcs	₹ 3,200/pc
Admissible Temp.	-30°C to +50°C		TAM-SLB (optional)	Infrared Safety Light Barrier	1 Pair	₹ 9,000
Admissible Humidity	35 - 85% RH (non-condensing)		TAM-GAC	Aluminium Clamps for Glass	1 Pair (1/1.5 Mtr)	₹ 9,200/ ₹ 13,200
Extensions	Safety light barrier, such as remote control of various types of access control		TAM-GFG	Floor Guide for Glass Door	1 Pair	₹ 1,150
			TAM-WFG	Floor Guide for Wooden Door	1 Pair	₹ 1,800

* 18 months warranty

TERRIFIC SLIDE

TAM-TS-200

Available in 4.2mtr & 6mtr Track Length

4.2mtr	₹ 2,20,000/set
6.0mtr	₹ 2,35,000/set

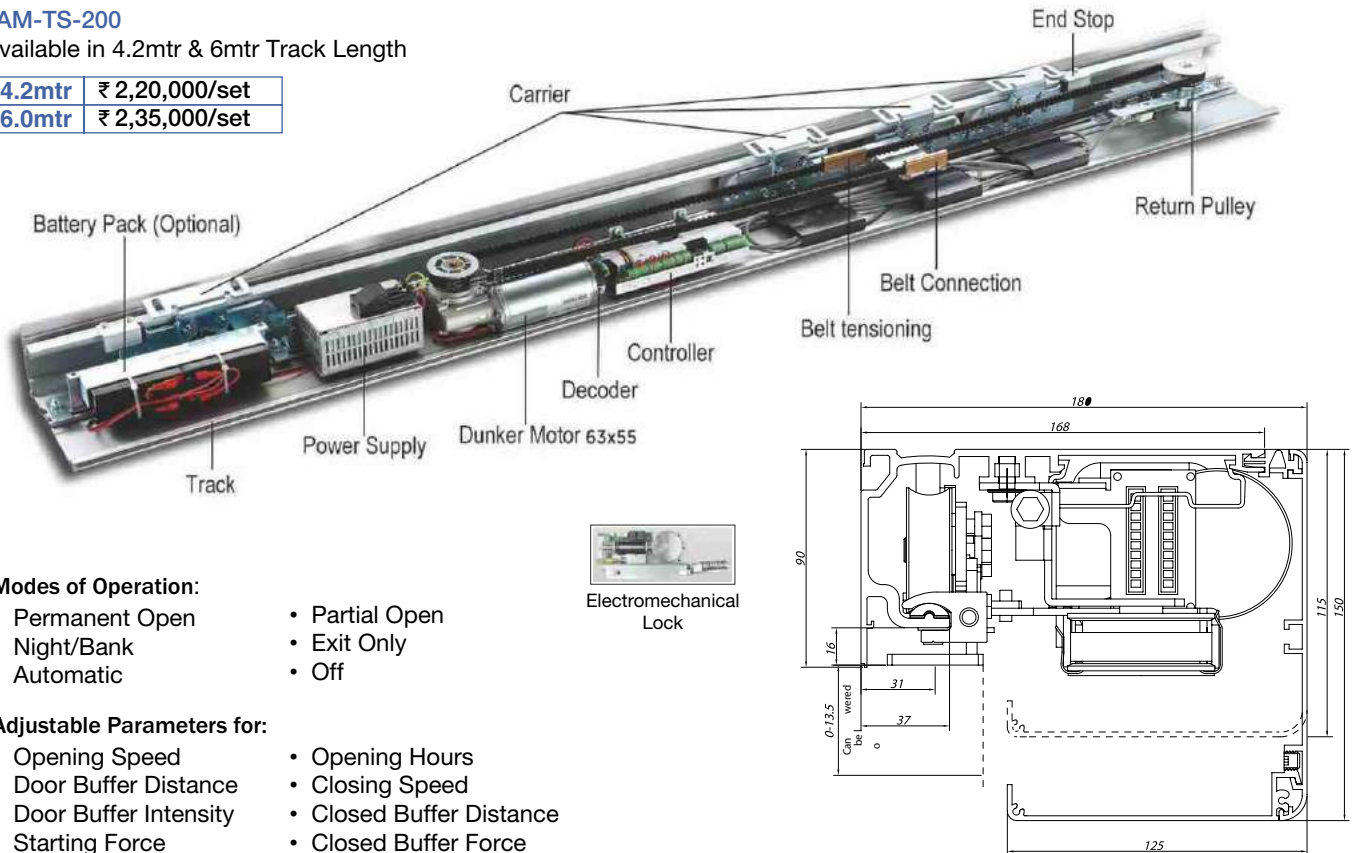

Modes of Operation:

- Permanent Open
- Night/Bank
- Automatic
- Partial Open
- Exit Only
- Off

Adjustable Parameters for:

- Opening Speed
- Door Buffer Distance
- Door Buffer Intensity
- Starting Force
- Opening Hours
- Closing Speed
- Closed Buffer Distance
- Closed Buffer Force

PART LIST

Specification	TAM-TS-200 (4.2 Mtr/6 Mtr)		STANDARD			
	Single Door	Double Doors	Product Code	Fitting	Quantity	MRP
Horizontal Pull	Single Door	Double Doors	TAM-TS-200 TRACK	Track	1 Pcs (4.2/6 Mtr)	₹ 45,600/ ₹ 77,000
Leaf Weight	<200Kg	<150kg x 2	TAM-TS-200-CNTR	Controller	1 Pcs	₹ 63,000
Width of Door	700-3000mm	400-1500mm	TAM-TS-200-MT	Motor	1 Pcs	₹ 63,000
Controller	High-Performance Digital Micro-Controller		TAM-TS-200-PS	Power Switch	1 Pcs	₹ 2,100
Motor	Dunker motor GR 63x55 24V 95W with decoder		TAM-TB	Toothed Belt	1 Pcs (8/12 Mtr)	₹ 750/mtr
Opening Speed	100 - 700mm / s (adjustable)		TAM-BC	Belt Connection	1 Set	₹ 1,200
Closing Speed	100 - 500mm / s (adjustable)		TAM-TS-200-RC	Remote Control	1 Pair	₹ 2,300
Door Hold Time	0 - 180 s (adjustable)		TAM-TS-200-TW	Adjustable Tension Wheel	1 Pcs	₹ 4,300
IP Protection Class	IP20		TAM-MS	Sensor	2 Pcs	₹ 8,200/pc
Opening Direction	Optional		TAM-TS-200-STPR	Stopper	1 Pcs	₹ 1,600
Supply Voltage	AC230V 50/60Hz		TAM-TS-200-HGR	Hanger	4 Pcs	₹ 4,000/pc
Rated Power	200W		TAM-SLB (optional)	Infrared Safety Light Barrier	1 Pair	₹ 9,000
Admissible Temp.	-20°C to 60°C		TAM-GAC	Aluminium Clamps for Glass	1 Pair (1/1.5 Mtr)	₹ 8,800/ ₹ 12,600
Admissible Humidity	93%		TAM-GFG	Floor Guide for Glass Door	1 Pair	₹ 1,150
Extensions	Safety light barrier, such as remote control of various types of access control		TAM-WFG	Floor Guide for Wooden Door	1 Pair	₹ 1,800
Optional	Electromechanical Lock, Battery Pack					

* 24 months warranty

AUTOMATIC SLIDING DOORS



ECO SLIDE

TAM-ES-01

Available in 4.2mtr & 2.5mtr Track Length

4.2mtr	₹ 1,20,000/set
2.5 mtr	₹ 90,000/set

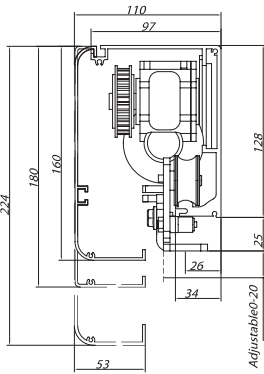
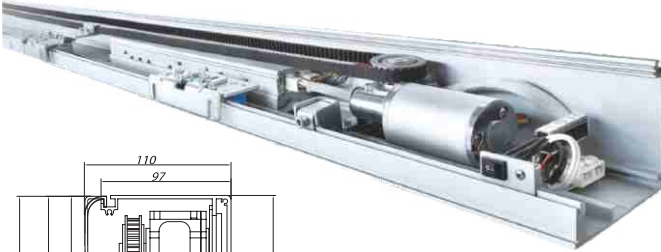

Specification	TAM-ES-01 (4.2 Mtr)	
Horizontal Pull	Single Door	Double Doors
Leaf Weight	<120Kg	<100kg x 2
Width of Door	700-1300mm	600-1050mm
Controller	High-Performance Micro-Controller	
Motor	DC 24V 55W Brushless Motor	
Opening Speed	< 400mm / s (adjustable)	
Closing Speed	< 300mm / s (adjustable)	
Door Hold Time	0.5 - 10s (adjustable)	
Manual Thrust	< 45N	
Opening Direction	Optional	
Supply Voltage	AC AC220-250V 50/60Hz	
Admissible Temp.	-30°C to +50°C	
Admissible Humidity	35 - 85% RH (non-condensing)	
Extensions	Safety light barrier, such as remote control of various types of access control	

PANIC BREAK OUT

TAM-PBO

Customized Doors

The full breakout sliding door is specially designed to meet emergency escape requirements. In an emergency, the sliding doors & fixed panels can be pushed straight away to facilitate escape. These doors give an emergency opening of about 85% to 90% of the structure width.



Double-leaf, standard operation

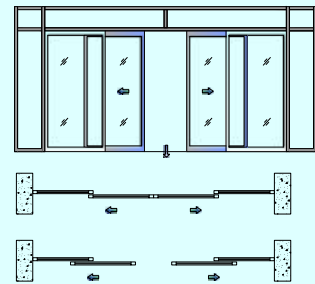

Double-leaf, escape situation

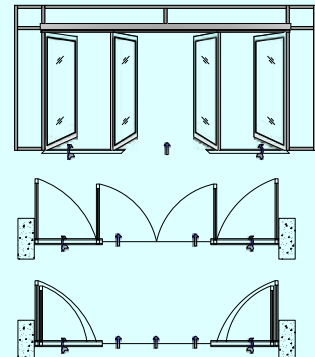

Clear opening width with sliding doors	700-2500mm
Clear opening height	2000-3300mm
Max. clear opening width in break out situation	5000mm

* 12 months warranty

RETRO SWING - SURFACE (Wooden Doors)



Advanced Operating System

High efficient and small drive torque DC brushless motor, gentle opening and closing, smooth braking, energy saving & environmental protection.

Safety

Excellent pinch performance. The door returns back automatically in case of any obstacle or resistance during closing.

Convenient

Modular & compact design, beautiful appearance, easy installation.

Reliable

New drive, high quality DC Brushless motor, gear box helical gears, wheels and high wear characteristics reasonable structural design makes it reliable, quiet operation and longer life

Compatible

Standard configuration can be integrated with variety of additional accessories as per the site requirements.



Scan for Product Video

TAM-ASD-01 ₹ 85,000

For Single Action Doors

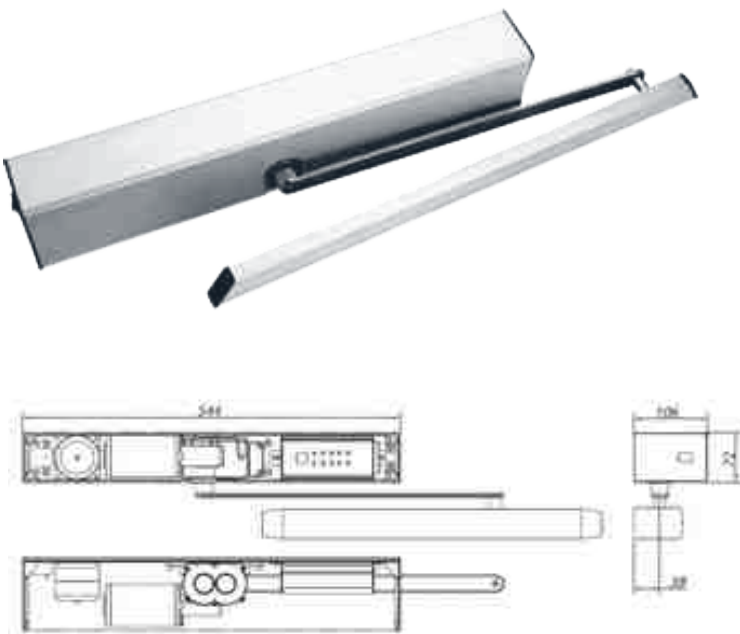

Specification	TAM-ASD-01
Controller Dimensions	85 x 124 x 600mm
Weight	12 Kg
Max Door weight	200 Kg
Open Range	70° to 115°
Closing Speed	100 to 400 mm/s (adjustable)
Door Hold Time	0.5 – 10s (adjustable)
Opening Direction	Optional
Supply Voltage	AC 220V~250V, 50/60Hz
Max current	1A
Max Motor Power	55W
Wait Power	14W
Fuse	Min 3.5A Slow
Admissible Temperature	-30°C to +50°C

* 12 months warranty

RETRO SWING - BOTTOM



Advanced Operating System

High efficient and small drive torque DC brushless motor, gentle opening and closing, smooth braking, energy saving & environmental protection.

Safety

Excellent pinch performance. The door returns back automatically in case of any obstacle or resistance during closing.

Convenient

Modular & compact design, beautiful appearance, easy installation.

Reliable

New drive, high quality DC Brushless motor, gear box helical gears, wheels and high wear characteristics reasonable structural design makes it reliable, quiet operation and longer life

Compatible

Standard configuration can be integrated with variety of additional



Scan for Product Video

TAM-CASD-03 ₹ 1,10,000

For Double Action Doors

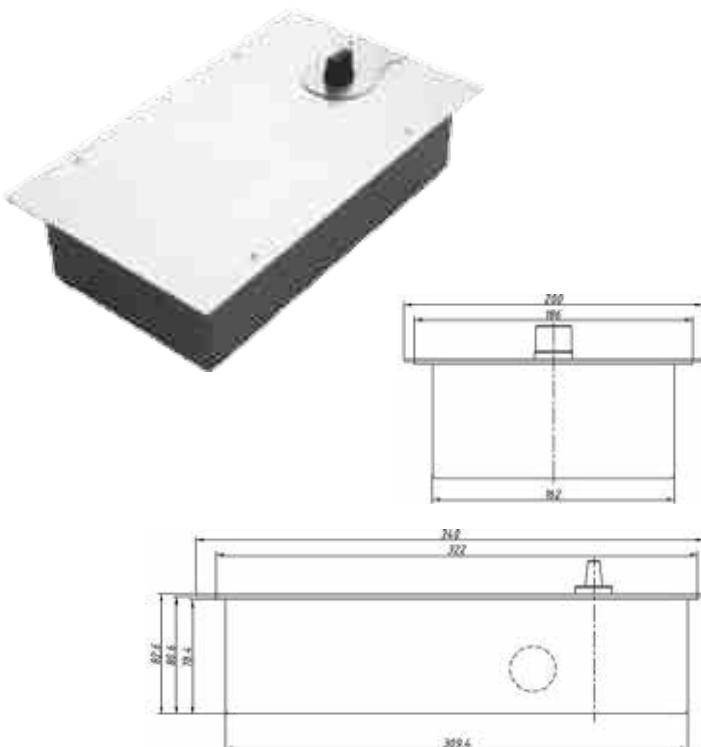

Specification	TAM-CASD-03
Dimensions	82 x 186 x 310mm
Controller	High Performance Micro-Controller
Motor	DC24V 45W Brushless Motor
Max Door weight	200 Kg
Open Range	± 90°
Opening & Closing Time	3 to 14 s
Door Hold Time	0.5 – 10s (adjustable)
Opening Direction	Optional
Supply Voltage	AC 220V~250V, 50/60Hz
IP Protection	IP44
Admissible Temperature	-30°C to +50°C
Admissible Humidity	35 - 85% RH (non condensing)
Extensions	Safety Light Barrier, such as remote control of various types of access control

* 12 months warranty

AUTOMATIC CURVED SLIDING DOORS



Drive Unit

Equipped with Dunker Motor drive unit. Integrated drive module combined with curved hardware realizes the superiority of curved shaped door in terms of structural stability & driving performance.

Exquisite Hardware Design

Design adopts the drive mode of synchronous wheel. Compared with traditional design, it reduce the loss of hardware during transmission, enabling smooth & noise free operation of the door.

Liberty of Design

Design can be customized into Half circles, full circles, ovals, segments, double segments etc.

Technical Specification

Standard Size

Convex		Concave	
Radius R in mm	Clear Width W in mm	Radius R in mm	Clear Width W in mm
1000	1200	1000	1240
1200	1450	1200	1500
1400	1720	1400	1760
1600	1980	1600	2010
1800	2240	1800	2270
2000	2500	2000	2530

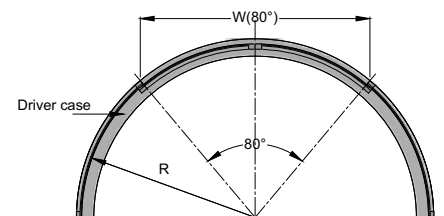

Convex Installation

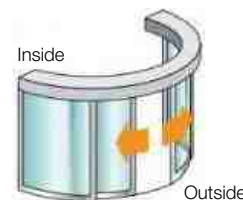

Concave Installation

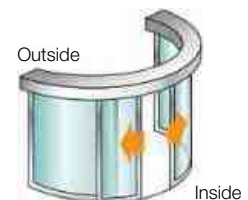

Technical Data

Mains power supply	230V, 50/60Hz, 13A
Mains cable	4mtr length
Rated power	100W
Static drive power	Max. 150N
Admissible temp.	-15 to 50°C

Functions

Adjustable speed	500 – 700 cm/s
Electronic control panel	Yes
Auto-reverse safety mechanism	Yes
Safety stopping mechanism	Yes
Battery pack (24V)	Optional
Locking	Optional
Manual unlocking inside/outside	Optional

Components

Dunker Motor	30V 100W DC Motor GR 63x55, IP 65 with Encoder, 3350 rpm
Micro Controller	Connections port for Safety sensor with adjustments of all basic parameters via integrated display & pushbuttons. 24V output for external accessories
Power supply	Input 80-250V AC, output 35V DC

* 12 months warranty

MANUAL & AUTOMATIC REVOLVING DOORS



Features:

- Offer Impressive aesthetic appearance
- Effectively separate indoor and outdoor conditions
- Minimize building's heating & air-conditioning losses, maximizing energy savings
- Equipped with drive units and sensor systems makes the door operate automatically
- Key switch has 3 functions; night lock, go-stop and continuous revolving
- Disabled access function slow the door speed for young, old & differently abled
- Emergency stop button to stop the door movement in emergency
- Manual doors does not require electric power and will never suffer from severe weather conditions.

Specifications:

Diameter	1800-3600 mm
Height	Max. 2700mm
Door Leaf	3 / 4 leafs
Speed	1-4 rpm

TOUCHLESS HAND SENSOR

TAM-MS-THS ₹ 19,000

Touchless Intentional Sensor for Automatic Doors

Magic Switch is an intentional touchless microwave sensor which reacts to every intentional motion approaching and allowing to activate the door without any physical contact with the sensor.

In addition to the comfort, it offers a Hygienic opening solution for the Hospitals, Hotels, Restaurants, Retail, Pharmaceutical Industries & Logistics.

Features

- Microwave module with an adjustable detection area from 10 to 50 cm
- Ideal Hygienic Solution for the Retail, Pharmaceutical, Chemical & Healthcare sectors.
- Efficient alternative to push-buttons and other manual solutions.
- The microwave technology allows to hide the sensor behind any non metallic material for aesthetics and safety

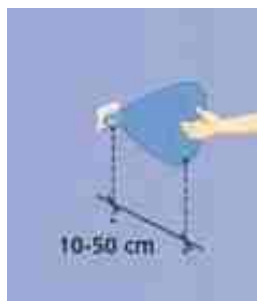

Technology	Microwave motion sensor
Radiated frequency	24.150 GHz
Radiated power density	< 5 mW/cm ²
Detection range (hand)	+/- 10 to 50 cm if movement towards sensor at 90° (adjustable)
Detection mode	Motion (bidirectional)
Speed of target for detection	Min. 5Hz or +/- 3 cm/s, Max. 200 Hz or +/- 1.2 m/s
Supply voltage	12V - 24V AC ± 10 % 12V - 30V DC -5%/+10%
Mains frequency	50 - 60 Hz
Power consumption	< 1.2 W
Output Max. voltage Max. current Max. switching power	Relay with switch-over contact (free of potential) 48 V AC - 60 V DC 1A (resistive) 30 W (DC) / 48 VA (AC)
Output hold time	0.5 s (in PULSE mode)
Temperature range	-20°C to +55°C
Degree of protection	IP 30 with cable connected IP40 flush-mounted without front face IP52 flush-mounted with front face and silicone seal mounted in surface mount box
Material	ABS/Polycarbonate
Color	White
Dimensions	85 mm (L) × 85 mm (H) × 45 mm (W)

TAM-MS-ZS ₹ 14,000

Dual Technology Sensor combining the microwave technology for the opening and active infrared technology for the safety

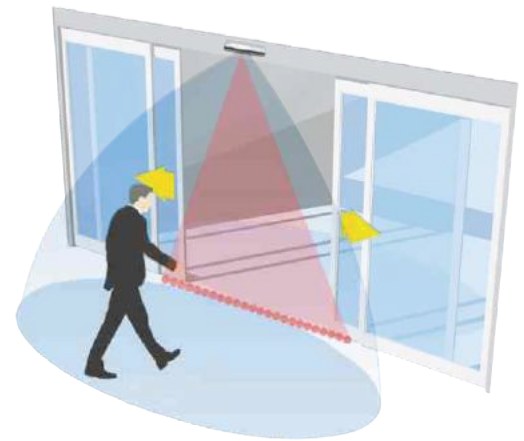
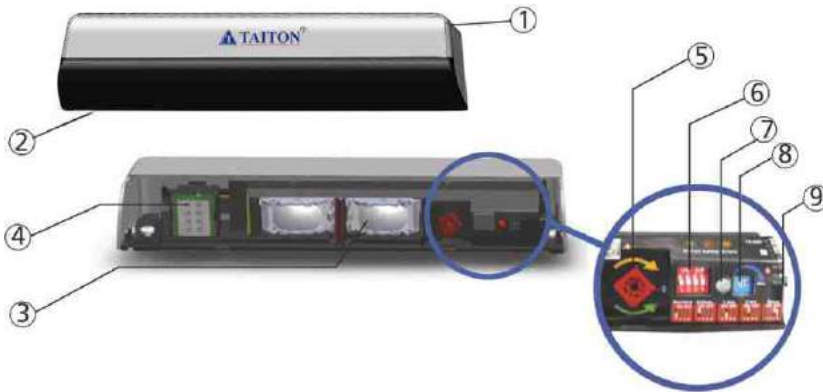

- | | |
|--------------------------------|--------------------------------------|
| 1. Cover | 6. Dip switch |
| 2. Front cover | 7. LED |
| 3. Infrared lens | 8. Microwave sensitive potentiometer |
| 4. Microwave antenna | 9. Cable plug |
| 5. IR-curtain adjustment screw | |

Technical Specification

Supply voltage	12 V - 24 V AC +/-10% ; 12 V - 30 V DC -5%/+10%
Power consumption	< 3 W (VA)
Mounting height	1.8 m to 3 m
Admissible Temperature	-25 °C to +55 °C
IP Protection Class	IP54



Detection mode	Motion Min. detection speed: 5 cm/s	Presence Typical response time: <128 ms (max. 500 ms)
Technology	Microwave doppler radar Transmitter frequency: 24.150 GHz Transmitter radiated power: < 20 dBm EIRP Transmitter power density: < 5 mW/cm ²	Active infrared with background analysis Spot diameter: 6 cm (typ) Number of spots: 24 by curtain Number of curtains: 1
Angle	From 15 ° to 45 ° vertical (adjustable)	From -5 ° to +8 ° (adjustable)
Output	Relay (free of potential change-over contact) Max. contact voltage 42V AC/DC Max. contact current 1A (resistive) Max. switching power 30W (DC)/60VA (AC)	Relay (free of potential change-over contact) 42V AC/DC 1A (resistive) 30W (DC)/60VA (AC)
Hold time output signal	0.5 s	0.5 s

Taiton reserves the right to change the specifications without prior notice

TAM-MS ₹ 8,200

Economical bi-directional radar sensor for automatic sliding doors.

Technical Specification	
Technology	Microwave and Microprocessor
Transmitter frequency	24.125 Ghz
Transmitter radiated power	<20dBm EIRP
Transmitter power density	<5m W/cm ²
Detection mode	Motion
Minimum detection speed	5 cm/s (measure in the sensor axis)
Supply voltage	12V-24V AC+/-10%, 12V-30V DC
Mains frequency	50 to 60 Hz
Max. power consumption	< 2W (VA)
Output	Relay (free of potential change-over contact)
Max. contact voltage	42V AC/DC
Max. contact current	1A (resistive)
Max. switching power	30W (DC)/60VA (AC)
Max. mounting height	3 mtr
IP Protection Class	IP54
Admissible Temperature	-20°C to +55°C



Taiton reserves the right to change the specifications without prior notice

WIRELESS PRESS BUTTON

TAM-WPB ₹ 18,500

Features

- Sensitive FM Wireless switch can be integrated with all types of Automatic Doors
- Uses Radio wave to transmit the signal
- Very convenient for places where laying wires is not possible

Power supply of Wireless Button	6V
Power Supply of received	AC/DC 12-36V
Output Capacity	10A 24V DC
Wireless Button Dimensions	203 x 41 x 12.5mm

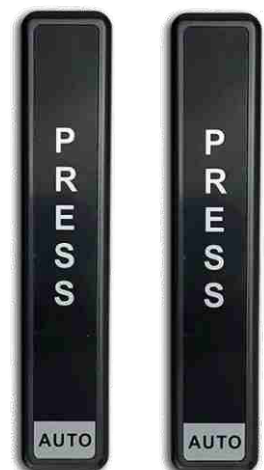

AUTO DOOR ACCESSORIES

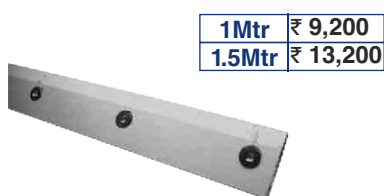

1Mtr ₹ 9,200
1.5Mtr ₹ 13,200

TAM-GAC

Aluminium clamp
Available in 1 mtr. & 1.5 mtr (pair)



TAM-GFG ₹ 1,150

Floor guides for frameless glass doors (pair).



TAM-WFG ₹ 1,800

Floor guides for framed doors with adjustable width (pair)



TAM-SW-11 ₹ 900
SW-11M ₹ 1,300

Large area push button for automatic doors

TELESCOPIC SLIDING FRAMELESS GLASS DOOR SYSTEM

TAITON features A telescopic sliding frameless glass door system is a type of door system that features two or more glass panels that slide horizontally along a track, allowing the door to open and close without a traditional frame. The term "telescopic" refers to the fact that the panels can overlap or "telescope" one another as they slide, allowing the door to fully open with minimal clearance required.

This type of door system is often used in commercial or residential settings where a modern, sleek appearance is desired. Because the door panels are made of glass and there is no visible frame, the system can provide a seamless transition between interior and exterior spaces and allow natural light to flow freely throughout a room.

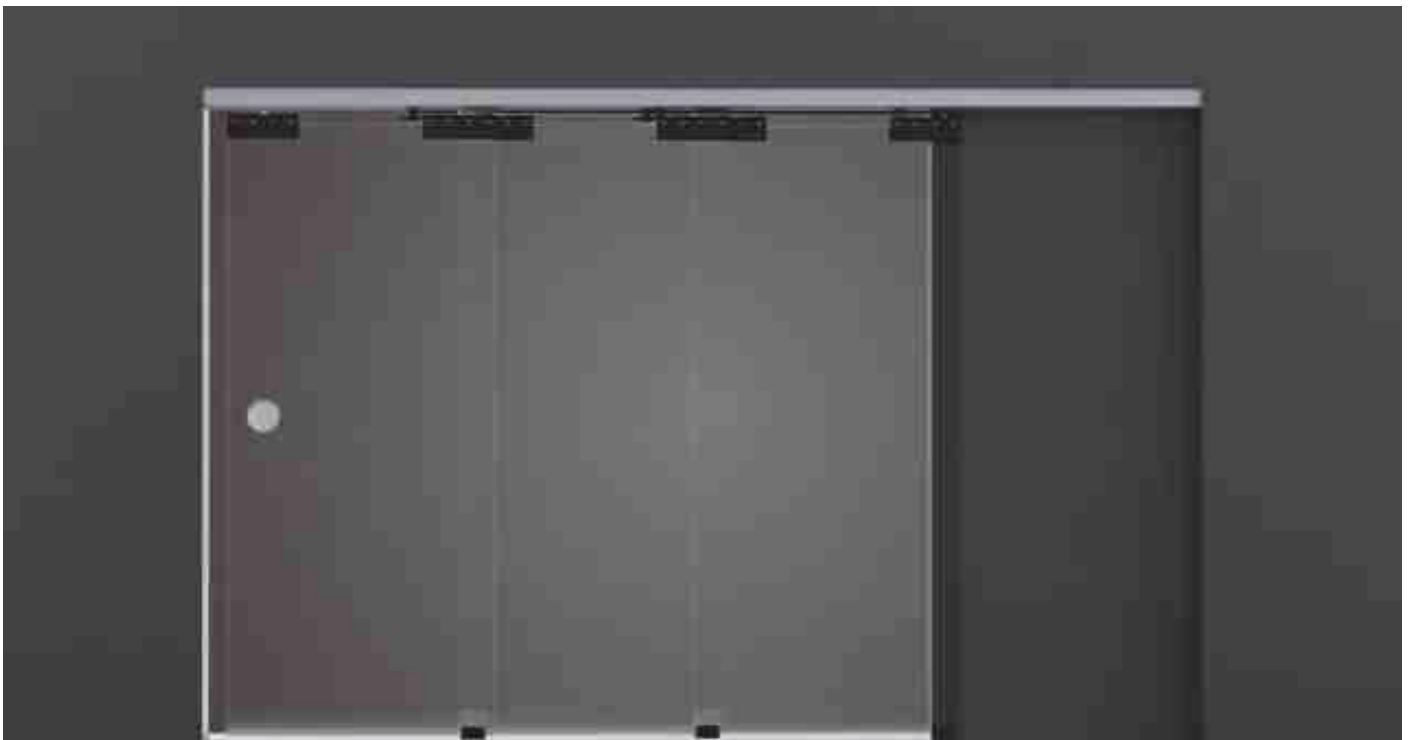

TELESCOPIC SLIDING FRAMELESS GLASS DOOR SYSTEM



Glass Thickness : 8-12mm
 Min Door width : 550 mm
 Max Door width : 1200mm

Telescopic Sliding Frameless Glass 2 Door System

TSL-FL-02 ₹ 45,000

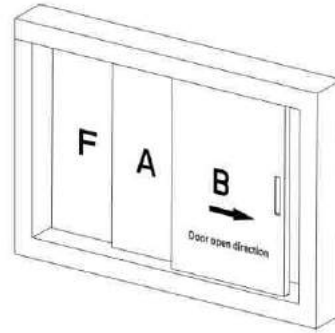

Telescopic Sliding Frameless Glass 3 Door System

TSL-FL-03 ₹ 56,000

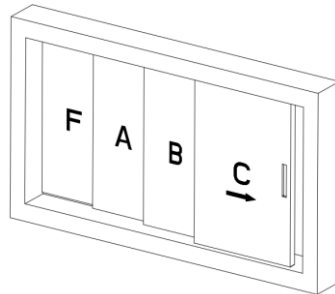

Telescopic Sliding Frameless Glass 4 Door System

TSL-FL-04 ₹ 66,000

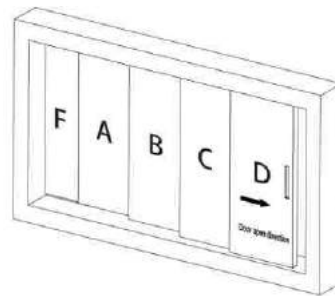

TAV-HD-TT (Top Track)



3mtr	SILVER	₹ 6,840
	BM	₹ 7,000
	B.GOLD	₹ 7,500
4mtr	SILVER	₹ 9,120
	BM	₹ 9,350
	B.GOLD	₹ 10,000
5mtr	SILVER	₹ 11,400
	BM	₹ 11,700
	B.GOLD	₹ 12,500
6mtr	SILVER	₹ 13,680

TAV-HD-TT-COVER-FL (Top Track Cover)



5mtr	SILVER	₹ 5,900
	BM	₹ 6,300
6mtr	SILVER	₹ 7,000
	BM	₹ 7,600

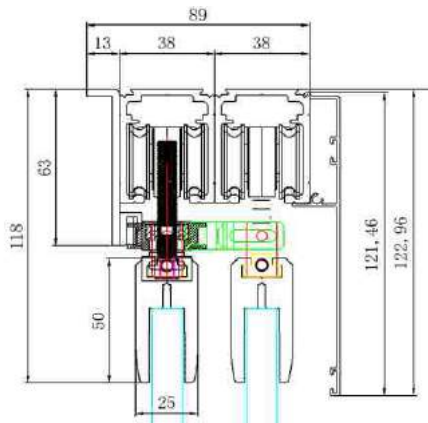



RFID CARD LOCKS

TAITON features stylish, Innovative & affordable Electronic RFID Hotel Locks. Manufactured from heavy duty materials, RFID Hotels Locks are available in various designs & finishes to select from to suit your interior scheme.

Our RFID locks have various certifications like Intertek, CE & manufactured as per ISO 9001 to ensure smooth & unmatched guest convenience.



RFID CARD LOCKS



HOTEL RFID CARD LOCKS

2 years Warranty

SS 304



TAM-RF-LEANA-R/L-SSS ₹ 12,400

Finish: Satin
Min. Door Thickness: 30mm



TAM-RF-URBANA-R/L-SSS ₹ 12,500

Finish: Satin
Min. Door Thickness: 38mm



TAM-RF-ARENA-R/L-PSS ₹ 16,100

TAM-RF-ARENA-R/L-SSS ₹ 16,100

TAM-RF-ARENA-R/L-GOLD ₹ 16,100

Finish: Polished
Min. Door Thickness: 38mm

HOTEL RFID CARD LOCK WITH BLUETOOTH FUNCTION



TAM-RF-MAGNA-R/L-BM ₹ 21,100

Finish: Black Matte
Min. Door Thickness: 38mm



TAM-RF-PLATINA-R/L ₹ 23,500

Finish: Coffee Golden
Min. Door Thickness: 38mm



TAM-RF-DIVINA-BTH-R/L-SSS ₹ 30,000

Finish: Satin
Min. Door Thickness: 38mm

ACCESSORIES FOR RFID CARD LOCKS

WHITE ₹ 160
BLACK ₹ 160



TAM-RF-CARD
Mifareone Card



TAM-RF-QC-CARD
Query Card ₹ 2,100



TAM-RF-CR ₹ 26,000
Encoder



TAM-RF-PDA ₹ 76,000
Personal Digital Assistant

WHITE ₹ 3,500
BLACK ₹ 3,800



TAM-RF-PS
Power Saver



TAM-RF-SW ₹ 26,000
Software

TAITON in Collaboration with Revo-Ex Presents: Smart Hotel Locks & Guest Management Solution

- Mobile/Kiosk Check-In
- Mobile Checkout & Payment
- Personalized Offers
- Digital Key & Power
- Digital Dining Experience
- Online Service Requests



TAM-RF-ECS (Intelligent Elevator Control System)

₹ 1,85,000



Card Reader



Multiple Elevator Control Box



- 16 Floor Elevator Controller
- Guest card can open the elevator at designated floor

DND SYSTEM



Functions:

- Hotel Name Display
- Room Number Display
- Make up Room
- Do Not Disturb
- Door Bell



TAM-RF-DND-OP ₹ 9,000

Outside panel
Do Not Disturb System for Hotel Room



TAM-RF-DND-IP ₹ 6,000

inside panel
Do Not Disturb System for Hotel Room



TAM-RF-DND-DB ₹ 500

Dingdong bell

DIGITAL GLASS DOOR LOCKS



TAM-DL-SLIMSEC

Slim Digital Biometric Lock
for uPVC & Aluminium Profile Doors

TAM-DL-SLIMSEC(SWING) - R/L-BLACK	₹ 33,700
TAM-DL-SLIMSEC(SLIDING) BLACK	₹ 33,700



TAM-DL-REMOTE ₹ 5,000
Remote Control

FEATURES :-

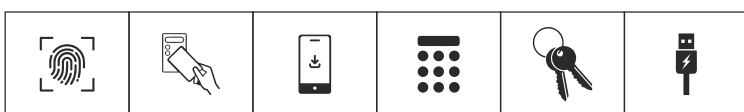

300 Fingerprint Capacity 300 Card Capacity Mobile App Password Pin Manual Key USB Interface

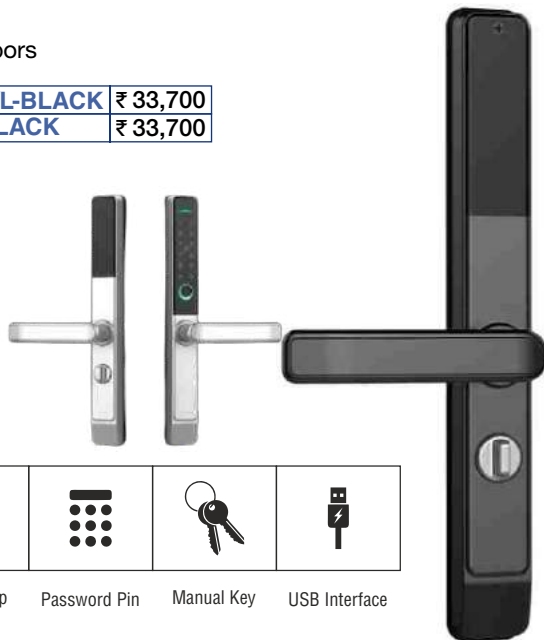

Touch keypad with Backlight & Waterproof Surface

NEW ARRIVAL
ORDER NOW



BIOMETRIC & DIGITAL GLASS DOOR LOCKS

NO Glass Cutout Required



TAM-DL-G2G BLACK ₹ 27,500

For Swing Door Lock With Strike Box

TAM-DL-G2W BLACK ₹ 27,000

For Swing Door Lock With Strike Plate

TAM-SDL-W2W-BLACK ₹ 27,500

For Woden Sliding Door

TAM-SDL-G2G-BLACK ₹ 27,500

For Glass Sliding Door

Features of RFID Locks:

- 5 way unlocking - Fingerprint, IC Card Password, Key & Remote Control
- Easy installation, no need Glass Preparation
- Automatic locking function
- Dual combination access
- Touch keypad with backlight & waterproof surface
- LED color screen to view all operations
- USB interface for emergency power supply
- Rotary switch & unlock button inside
- Low battery indicator
- Door bell function
- Suitable for glass door thickness 10-12mm
- Finger print capacity: 100 pcs
- Card capacity: 1000 pcs
- Password capacity: 1000 pcs
- Admissible Temperature: (-20°C to 55°C)
- Power supply - 4 x AA battery (4.5V - 6.5V)



TAM-DL-REMOTE ₹ 5,000
Remote Control



TAM-DL-SUPREMA-R/L-BLACK ₹ 37,500

Digital Biometric Residential Wooden Door Lock

Features

- 6 way unlocking - Fingerprint, RFID Card, Password, Mobile App (Bluetooth), Manual Key & Remote Control (optional)
 - Suitable for Door Thickness – 38mm - 100mm
 - Automatic locking function
 - Door failure alarm/anti demolition alarm
 - Effective unlock time 0.8 seconds
 - Touch keypad with backlight & waterproof surface
 - Voice prompt throughout the whole process
 - Adopt Semiconductor fingerprint for fast recognition Speed
 - USB interface for emergency power supply
 - 304 Stainless Steel Material
 - Low battery indicator
 - Size – 315*75 mm, Net Weight – 6.5 Kg
- Suitable for Security and Wooden Doors
 - Finger print: 100, Password: 10 (6-10 digits)
 - Card capacity: 50, Manual key: 02
 - Admissible Temperature: (-20°C to 60°C)
 - Power supply - 8 x AA battery (Working Volt. - DC 6V)



TAM-DL-SECURA-R/L-BLACK ₹ 33,700

Digital Biometric Residential Wooden Door Lock

Features

- 4 way unlocking - Fingerprint, RFID Card, Password, Manual Key
 - Suitable for Door Thickness – 38mm - 100mm
 - Automatic locking function
 - Door failure alarm/anti demolition alarm
 - Effective unlock time 0.8 seconds
 - Touch keypad with backlight & waterproof surface
 - Digital display throughout the whole process
 - Adopt Semiconductor fingerprint for fast recognition Speed
 - USB interface for emergency power supply
 - Panel Material: Aluminium Alloy
 - Low battery indicator
 - Size – 380*75 mm, Net Weight – 4.5 Kg
 - Suitable for Security and Wooden Doors
- Finger print: 100, Password: 10 (6-8 digits)
 - Card capacity: 50, Manual Key: 02
 - Admissible Temperature: (-20°C to 60°C)
 - Power supply - 4 x AA battery (Working Volt. - DC 6V)



TAM-DL-MICROSEC-R/L-BLACK ₹ 17,000

Digital Biometric Residential Wooden Door Lock

Features

- 5 way unlocking - Fingerprint, RFID Card, Password, Manual Key, App
 - Suitable for Door Thickness – 45mm - 100mm
 - Automatic locking function
 - Door failure alarm/anti demolition alarm
 - Volume Adjustment function
 - Touch keypad with back light & waterproof surface
 - Digital display throughout the whole process
 - Dual verification mode function
 - USB interface for emergency power supply
 - Panel Material: Alufer
 - Low battery indicator
 - Size – 248*60*20 (D) excluding handle
 - Suitable for Security and Wooden Doors
- Finger print: <=100, Password: <=100 (6-8 digits)
 - Card capacity: <=100, Manual Key: 02
 - Admissible Temperature: (-10°C to 60°C)
 - Power supply - 4.5V-6.5V



* 24 months warranty

DIGITAL BIOMETRIC DOOR LOCK

TAM-DL-MINISEC-R/L-BLACK ₹ 25,000

Digital Biometric Residential Wooden Door Lock

Features

- 4 way unlocking - Fingerprint, RFID Card, Password, Manual Key
- Suitable for Door Thickness – 38mm - 65mm
- Automatic locking function
- Effective unlock time δ 0.8 seconds
- Touch keypad with backlight & waterproof surface
- Voice prompt throughout the whole process
- Adopt Semiconductor fingerprint for fast recognition Speed
- USB interface for emergency power supply
- Panel Material: Zinc Alloy
- Low battery indicator
- Size – 355x75 mm, Net Weight – 4.0 Kg
- Suitable for Security and Wooden Doors
- Finger print: 100, Password : 100 (6-8 digits)
- Card capacity: 100, Manual Key : 02
- Admissible Temperature: (-10°C to 60°C)
- Power supply - 4 x AA battery (Working Volt. - DC 6V)



DIGITAL BIOMETRIC DOOR LOCK

TAM-DL-NIRVANA-R/L-GRAY ₹ 68,000

TAM-DL-NIRVANA-R/L-BLACK ₹ 68,000

Password & Fingerprint Wooden Door Lock

Features

- 4 way unlocking - Fingerprint, Card, Password, Manual Key & Mobile App Digital Door Viewer
- Mortise- 60-68mm Center Distance
- SS 304

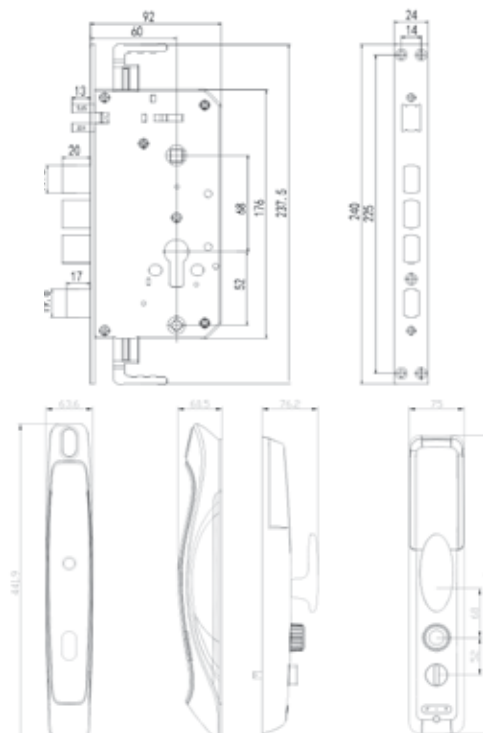

ACOUSTIC & GLASS MOVABLE PARTITIONS

TAITON features Acoustic Sliding Wall Partitions which are designed as non load bearing sliding and folding walls according to the sound rating required. These can maximize your potential for increased revenue by increasing your available space in completely flexible way.

We offer Acoustic sliding panels suspended from Aluminum track in ceiling to subdivide open areas which is flexible for events like weddings and conferencing simultaneously in a single big hall. We also offer Movable Glass Partition system with streamlined design without any visual obstruction therein. In addition, the movable glass partitions are more transparent where both upper and lower door patches are connected into integrity to ensure stability and smoothness so only one person can complete the whole partitioning process.



MANUAL ACOUSTIC SLIDING WALL PARTITION

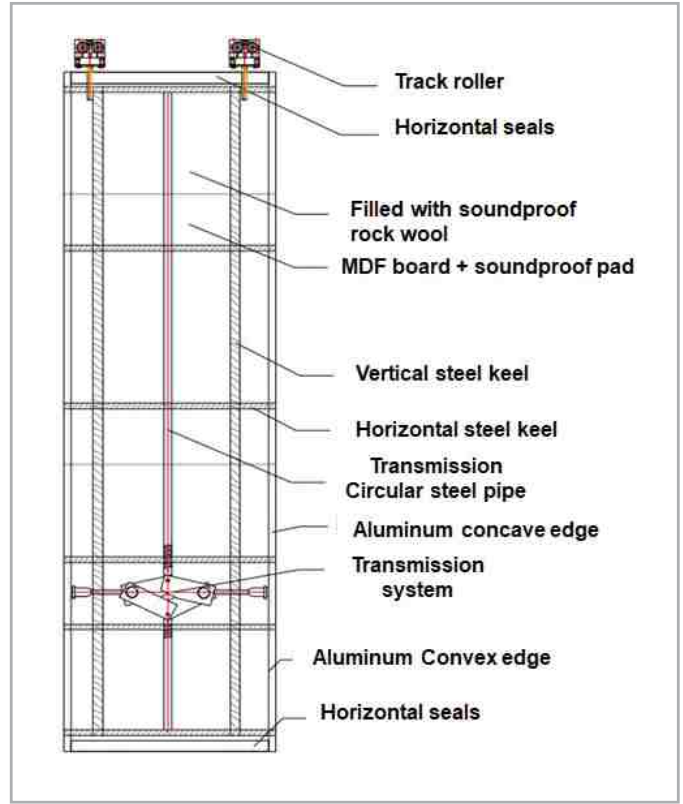
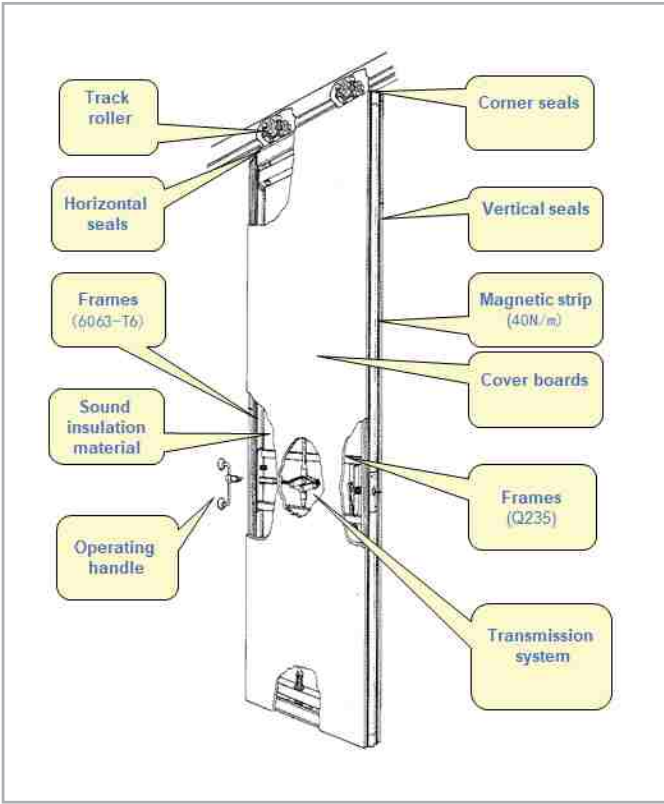

SPECIFICATIONS:

- Designed according to the sound rating required.
- Several choices for how the panels stack to the side of opening.
- Top Hung system without the need for a floor track.
- Manually operated Acoustic panels which can be linked together to form an acoustic sliding wall partition.
- High Quality multi-directional roller assemblies ensures smooth and silent movement.
- Panels will seal acoustically to track by sweep seals and to the floor by retractable seals.

STC	Panel Thickness	Max. Height	Max. Panel Width
35 dB	65mm	6mtr	1250mm
45 dB	85mm	12mtr	1250mm
53 dB	100mm	12mtr	1250mm

Semi Automatic & Automatic Acoustic Sliding Wall Partition also Available

PANEL STACKING OPTIONS

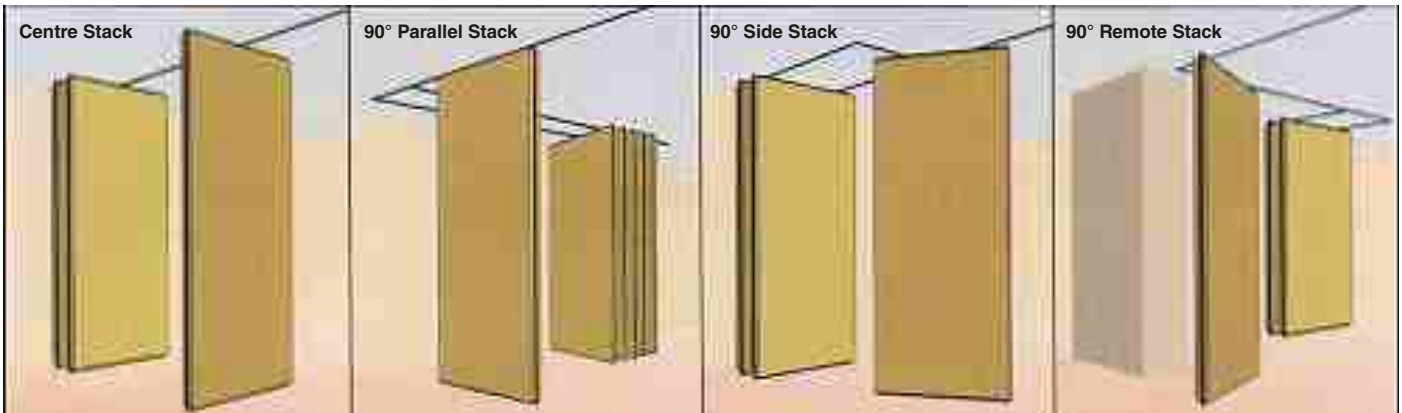

Any other panel stacking can be done as per site requirements

Description	Manual partition	Semi-automatic partition	Fully automatic partition
Height	12mtr	9mtr	9mtr
Thickness	100mm	100mm	100mm
Weight	55kg/m ²	30kg/m ²	30kg/m ²
Sound insulation	53dB	55dB	55dB
Track system	Steel track, load-bearing capacity upto 3500kg/m	Steel track, load-bearing capacity upto 3500kg/m	Steel track, load-bearing capacity upto 3500kg/m
Sealing system	Manual, continuous shaking	Electric control, double motor	Electric control, double motor
Operations use	Manual push door, Manual seal	Manual push door, Electric seal	Fully Automatic, Electric seal
Starting thrust	20kg	5kg	5kg
Layout time	(30pcs) 60min	(30pcs) 20min	(30pcs) 20min

SOFT CLOSE TELESCOPIC SLIDING SYSTEM

Features:

- Door panels stacking on one side in-line with top track
- Soft closing mechanism for smooth movement
- No track at the Bottom
- Suitable for Residences, Hotels, Offices etc
- Sliding track: Aluminium Anodized
- Hanging rollers: Zinc Alloy, SN
- Bracket: Iron, SN
- **Finish: Black Matte, Gold Matte**

MANUAL FRAMED DOOR

Features:-

Wt. Capacity	: 80kg
Door Thickness	: 30-45mm
Door Height Formula	: H-92mm
Door Width (Telescopic)	: 700-950mm
Door Width (Bi-parting)	: 700-950mm



TVC-3+1-AL



TVC-OOP-2+2-AL

MANUAL WOODEN DOOR

Features:-

Wt. Capacity	: 80kg
Door Thickness	: 45mm
Door Height Formula	: H-85mm
Door Width (Telescopic)	: 700-950mm
Door Width (Bi-parting)	: 700-950mm



TVC-3+1-WD



TVC-OOP-2+2-WD

MOVABLE GLASS PARTITION SYSTEM

TMPS-A-B

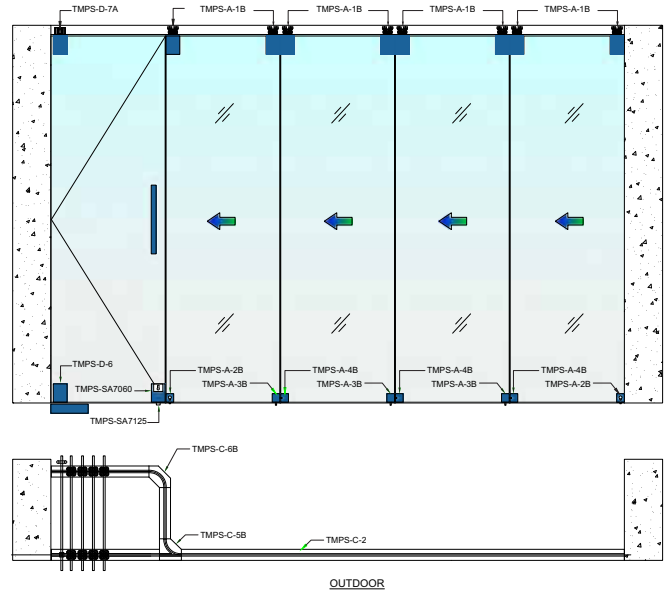

TMPS-A-1B ₹ 30,000
Top Glass Holder with Roller



TMPS-A-2B ₹ 12,000
Bottom Bolt (with hole)



TMPS-A-3B-L/R ₹ 12,000
Bottom Bolt (with side bolt)



TMPS-A-4B ₹ 12,000
Bottom Bolt



TMPS-C-5B-L/R ₹ 59,000
'T' Joint Module



TMPS-C-6B ₹ 37,000
'L' Joint Module



TMPS-D-6 ₹ 11,000
Bottom Patch Fittings



TMPS-D-7A ₹ 12,500
Top Patch Fittings



TMPS-SA7060 ₹ 7,500
Corner Patch Lock



TMPS-SA7125 ₹ 650
Strike Plate for SA7060



TMPS-C-2 Track ₹ 11,500
Standard Length: 3mtr/4mtr

WARDROBE SLIDING SYSTEMS

TAITON features Wardrobe sliding systems in all sort of sizes and designs to suit your clothes, style and space. These systems are manufactured using premium grade material in superior surface finish.

Our Wardrobes are very stylish and have the ability to give an elegant look to home or hotel bedroom.



CARNIVAL

TWS-KIT-HP1

2DOOR	BM/CHMP/GM	₹ 32,500
	R.GOLD	₹ 34,000
3DOOR	BM/CHMP/GM	₹ 47,500
	R.GOLD	₹ 49,500

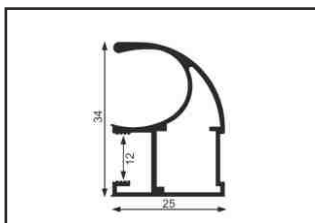

TWS-HP1

COSTA

TWS-KIT-HP2

2DOOR	BM/CHMP/GM	₹ 32,500
3DOOR	BM/CHMP/GM	₹ 47,500

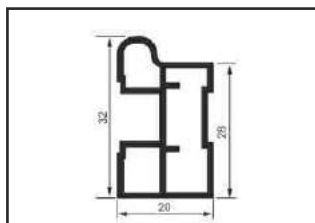

TWS-HP2

CELEBRITY

TWS-KIT-HP3

2DOOR	BM/CHMP	₹ 32,500
3DOOR	BM/CHMP	₹ 47,500

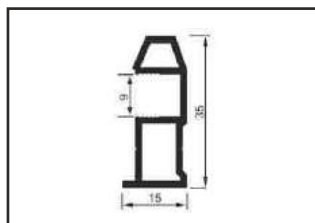

TWS-HP3

CAPRI

TWS-KIT-HP4

2DOOR	BM/IRON GRAY	₹ 38,000
-------	--------------	----------

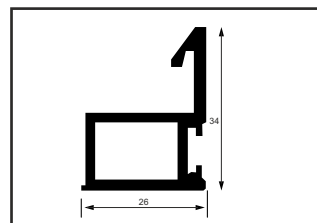

TWS-HP4

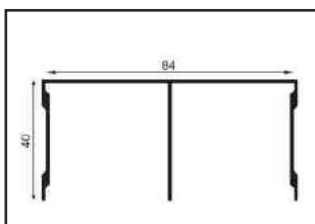

TWS-TT

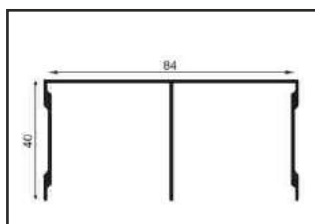

TWS-TT

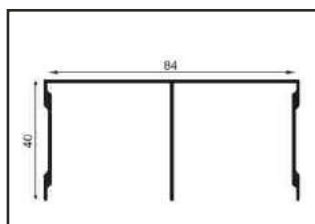

TWS-TT

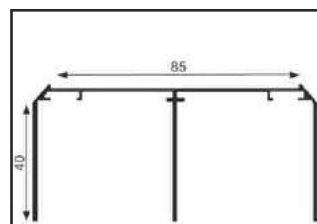

TWS-TT4

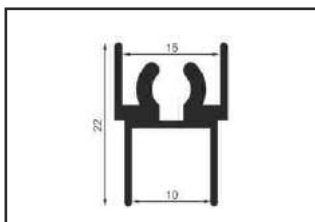

TWS-TP1

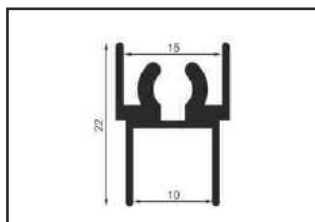

TWS-TP1

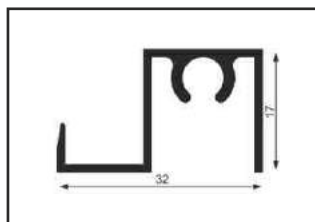

TWS-TP3

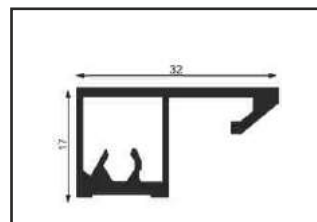

TWS-TP4

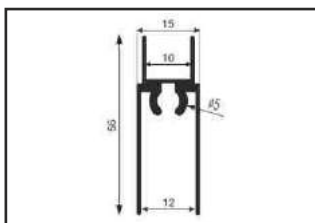

TWS-BP1

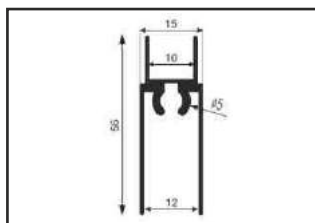

TWS-BP1

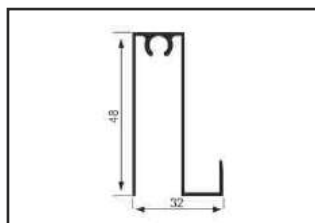

TWS-BP3

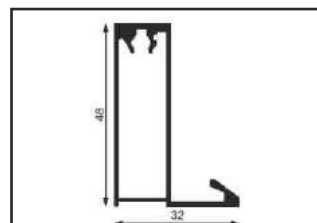

TWS-BP4

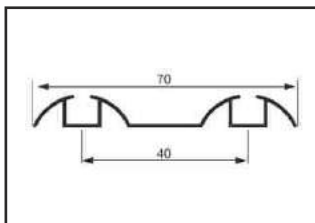

TWS-BT1

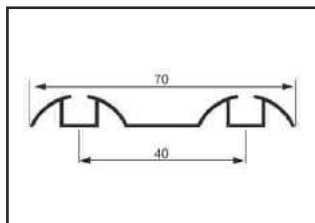

TWS-BT1

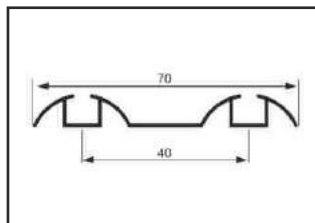

TWS-BT1

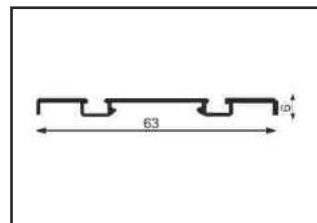

TWS-BT4

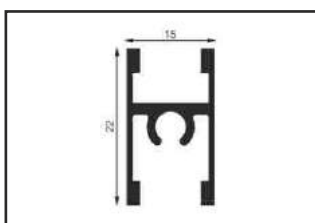

TWS-MP1

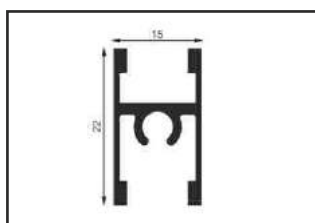

TWS-MP1

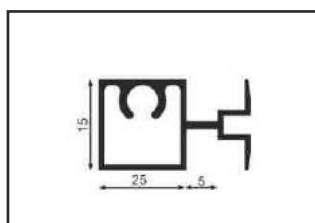

TWS-MP3

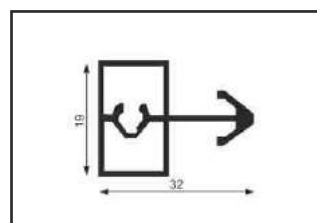

TWS-MP4

RAILINGS

TAITON features Railing systems in Stainless Steel and Aluminum. We offer wide range of Spigots to create Glass Fencing. We also offer Clear line Railing systems to create seamless glass railings for balconies, atriums, staircases etc.

Manufactured in Stainless Steel grade 304, it ensures durability and low maintenance covering the safety and aesthetical requirements.



SPIGOTS & CLEAR LINE RAILING SYSTEMS



SPIGOTS

SS 304

Finish: SSS/PSS



SSS	₹ 3,600
PSS	₹ 4,300

TBF-SG-B-6
6" Spigot With Base



SSS	₹ 2,900
PSS	₹ 3,350

TBF-SG-6
6" Spigot Without Base



SSS	₹ 3,500
PSS	₹ 4,100

TBF-SG-B-6W
6" Spigot With Base
(without cutout)



SSS	₹ 5,050
PSS	₹ 5,400

TBF-SG-B-12
12" Spigot With Base

ALUMINIUM

Finish: Silver Anodized



SSS	₹ 4,800
PSS	₹ 5,050

TBF-SG-B-9
9" Spigot With Base



SSS	₹ 5,650
PSS	₹ 5,900

TBF-SG-BR-9
9" Spigot With Base (Round)

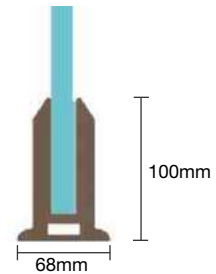

TBF-SG-AL-4 ₹ 2,350
Floor to Glass Clamp
Length 70mm

CLEAR LINE RAILING SYSTEM

ALUMINIUM

Finish: Silver Anodized

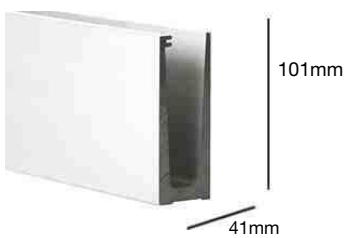

TCL-01 ₹ 7,000/mtr
Floor to Glass Clamp
Length : 3mtr

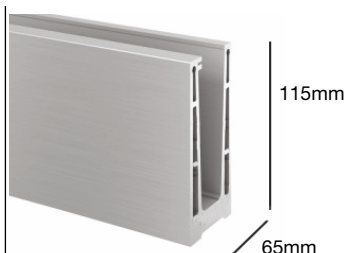

TCL-02 ₹ 10,000/mtr
Floor to Glass Clamp
Length : 3mtr

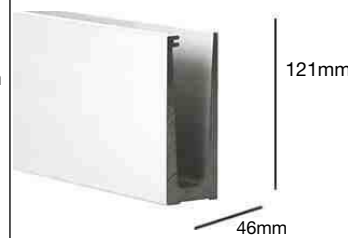

TCL-03 ₹ 9,000/mtr
Floor to Glass Clamp
Length : 3mtr

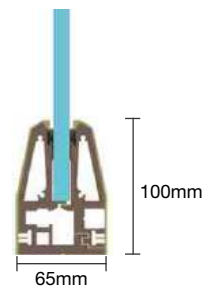

TCL-04 ₹ 3,000
Floor to Glass Clamp
Length : 140 mm



TCL-PC-04 ₹ 5,200
Profile Cover for TCL-04
Length : 4 mtr

FITTINGS FOR CLEAR LINE RAILING

25X21MM	₹ 2,650/pc
40X40MM	₹ 3,650/pc
60X40MM	₹ 4,000/pc



TRF-RCT-ADJ-90
90° Adjustable Connector for TRF-UTB-RCT-60-40

25X21MM	₹ 1,150/pc
40X40MM	₹ 2,150/pc
60X40MM	₹ 2,500/pc



TRF-RCT-180
180° Connector for TRF-UTB-RCT-60-40

25X21MM	₹ 500/pc
40X40MM	₹ 1,250/pc
60X40MM	₹ 1,400/pc



TRF-RCT-EC
End Cap for TRF-UTB-RCT-60-40

25X21MM	₹ 2,150/pc
40X40MM	₹ 2,900/pc
60X40MM	₹ 3,000/pc



TRF-UTB-RCT-WC
Wall to Handrail Connector for TRF-UTB-RCT-60-40

RAILING ACCESSORIES

SS 304

Finish: SSS/PSS

SSS	₹ 1,100
PSS	₹ 1,200



TRF-GH-01
Embedded Wall to Glass holder

SSS	₹ 2,000
PSS	₹ 2,100



TRF-GH-02
Embedded Wall to Glass holder

SSS	₹ 1,250
PSS	₹ 1,400



TRF-HR-01
Glass Mounted Adjustable Handrail Support

SSS	₹ 1,300
PSS	₹ 1,400



TRF-HR-W-01
Wall Mounted Adjustable Handrail Support

SSS	₹ 2,000
PSS	₹ 2,150



TRF-HR-02
Glass Mounted Adjustable Handrail Support

SSS	₹ 950
PSS	₹ 1,050



TRF-GC-01
Round Glass Clamp for Flat Surface

SSS	₹ 950
PSS	₹ 1,050



TRF-GC-02
Round Glass Clamp for Ø50mm Tube

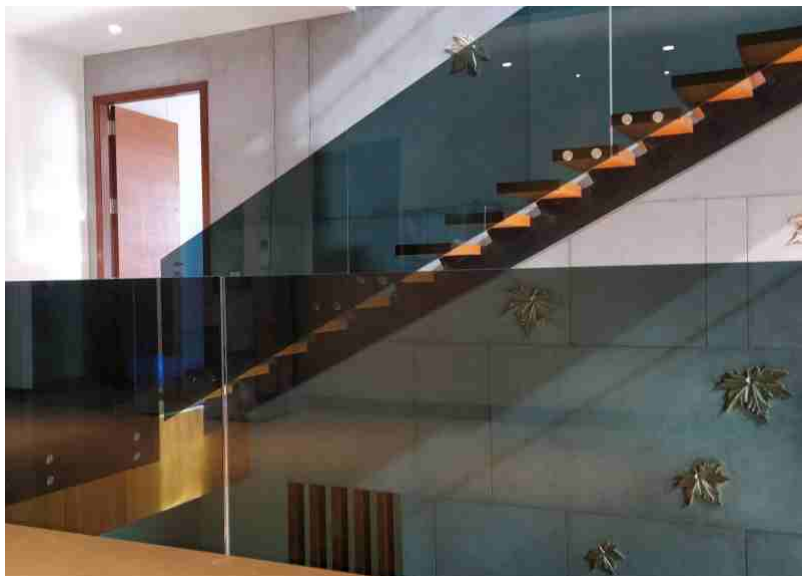

SMART SWITCH FILM

Introducing



Smart film is new electronic controlled optical product, with a scientific name of polymer dispersed liquid crystal film (PDLC FILM). In the switchable privacy film, small droplets of liquid crystal at micron meter level is dispersed in a polymer matrix, which is kept between two films. In order to produce this PDLC film, special process is required.

Applications:

- Corporate Offices
- Airports
- Hotels
- Medical Institutions
- Jewellery Showrooms
- Banks
- Shopping Malls
- Museums
- Residences

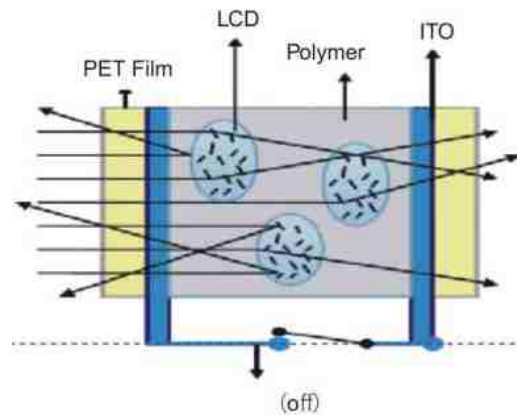

FILM PARAMETERS

Test Parameter		State	Results
Optics	Transmittance (parallel light)	Power on	About: 80%(+/-3%)
		Power off	1%
	Haze	Power on	4%
		Power off	90%
	Visual angle	Power on	about: 150°
	Screening of UV Light	Power on	>99%
Power off		>99%	
Screening of IR Light	Power on	>30%	
	Power off	>90%	
Electricity	(Power Adapter) Vop	Power on	60V AC/ 45V AC
	Responsive time	Power on → Power off	200 (ms)
		Power off → Power on	10 (ms)
Power	Power on	about: 5 W/m ²	
Size	Thickness	/	0.4mm
Environment	Operating Temperature	/	-10°C to 60°C
	Storage Temperature	/	-20°C to 60°C
Life	Life time	Power on	more than 50000Hr

* 24 months warranty



