

HÄFELE

Let's
Reimagine

TM

www.hafeleindia.com



GLASS FITTINGS PRICELIST

JUNE, 2022

Contents

Door Control Devices

PAGE

12-15

Patch Fittings

PAGE

16-18

Pull Handles

PAGE

19-21

Partition Systems

PAGE

22-23

Offset Pivot Hinges

PAGE

24-25

Stile Door Hardware

PAGE

26-33

Glass Door Locks

PAGE

34-36

Shower Fittings

PAGE

37-57

Glass Sliding Systems

PAGE

58-68

Door Control Devices



HYDRAULIC PATCH

931.46.256



Application: For wooden door
 Max. door leaf width: 1000 mm
 Max. door leaf weight: 100 kg
 Door thickness: min. 40 mm
 Material: SS 304 cover plate
 Dimension (HxWxD): 110 x 181 x 47 mm
 Tested to EN 1154
 Tested for 3,00000 cycles*
 Unit of measure: PC
 Price (INR): **18,100**

931.46.255



Application: For glass door
 Max. door leaf width: 1000 mm
 Max. door leaf weight: 100 kg
 Door thickness: 8 - 12 mm
 Material: SS 304 cover plate
 Dimension (HxWxD): 70 x 181 x 44 mm
 Tested to EN 1154
 Tested for 3,00000 cycles*
 Unit of measure: PC
 Price (INR): **16,875**

FLOOR SPRING

932.79.020

FS 2102



5 Years
Warranty

Double cylinder floor spring
 Door width: 750 - 850 mm
 Max. door weight: 70 kg
 Material: SS 304 cover plate
 Hold open: 90°
 Tested for 500,000 cycles*
 Unit of measure: PC
 Price (INR): **9,125**

932.79.030

FS 2103



5 Years
Warranty

Double cylinder floor spring
 Door width: 850 - 1000 mm
 Max. door weight: 90 kg
 Material: SS 304 cover plate
 Hold open: 90°
 Tested for 500,000 cycles*
 Unit of measure: PC
 Price (INR): **10,360**

932.79.040

FS 2104



5 Years
Warranty

Double cylinder floor spring
 Door width: 1000 - 1200 mm
 Max. door weight: 120 kg
 Material: SS 304 cover plate
 Hold open: 90°
 Tested for 500,000 cycles*
 Unit of measure: PC
 Price (INR): **11,050**

932.79.170



300 kg floor spring
 Door width: Max 1500 mm
 Max. door weight: 300 kg
 Material: SS 304 cover plate
 Tested for 500,000 cycles*
 Unit of measure: PC
 Price (INR): **45,895**

932.79.270



185 kg floor spring
 Door width: Max 1250 mm
 Max. door weight: 185 kg
 Material: SS 304 cover plate
 Tested for 500,000 cycles*
 Unit of measure: PC
 Price (INR): **20,530**

932.79.260

Special article**



2 Years
Warranty

Single cylinder floor spring
 Door width: Max 950 mm
 Max. door weight: 90 kg
 Material: SS 304 cover plate
 Tested for 500,000 cycles*
 Unit of measure: PC
 Price (INR): **6,120**

Note: *Hafele internal testing

932.86.031 FS 6100

5 Years Warranty



Heavy duty floor spring
 Door width: 1200 - 1400 mm
 Door weight: 600 kg (Double action)/ 400 kg (Single action)
 Material: SS 304 cover plate
 Profile: Heavy duty floor spring
 Unit of measure: SET
 Set: Floor Spring, Wooden accessories for single and double action door
 Price (INR): **1,11,358**

932.79.340



Single cylinder floor spring
 Door width: Max. 950mm
 Door weight: -100kg
 Material: SS 202 Cover plate
 Tested for 500,000 Cycles*
 Unit of measurement: PC
 Price (INR): **4,950**

FLOOR SPRING COMBO





	+		+		+		+		Combo Art. No. 932.79.300 Special article** Price (INR) 13,595 2 Years Warranty
932.79.260 Single cylinder floor spring, 90 kg, Door width: 950 mm		981.50.010 Bottom patch fitting, 10 -12 mm glass		981.50.020 Top patch fitting, 10 -12 mm glass		981.07.280 Top pivot		981.50.030 Corner patch lock with cylinder	



	+		+		+		+		Combo Art. No. 932.79.301 Price (INR) 16,595 5 Years Warranty
932.79.020 Double cylinder floor spring 2102, 70 kg, Door width: 750 - 850 mm		981.50.010 Bottom patch fitting, 10-12 mm glass		981.50.020 Top patch fitting, 10 -12 mm glass		981.07.280 Top pivot		981.50.030 Corner patch lock with cylinder	

	+		+		+		+		Combo Art. No. 932.79.302 Price (INR) 17,795 5 Years Warranty
932.79.030 Double cylinder floor spring 2103, 90 kg, Door width: 850 - 1000 mm		981.50.010 Bottom patch fitting, 10-12 mm glass		981.50.020 Top patch fitting, 10 - 12 mm glass		981.07.280 Top pivot		981.50.030 Corner patch lock with cylinder	

	+		+		+		+		Combo Art. No. 932.79.303 Price (INR) 18,495 5 Years Warranty
932.79.040 Double cylinder floor spring 2104, 120 kg, Door width: 1000 - 1200 mm		981.50.010 Bottom patch fitting, 10 - 12 mm glass		981.50.020 Top patch fitting, 10 - 12 mm glass		981.07.280 Top pivot		981.50.030 Corner patch lock with cylinder	

	+		+		+		<p>Combo Art. No.</p> <p>932.79.304 Special article**</p> <p>Price (INR) 10,095</p> <p>2 Years Warranty</p>
932.79.260 Single cylinder floor spring, 90 kg, Door width: 950 mm		981.50.010 Bottom patch fitting, 10 - 12 mm glass		981.50.020 Top patch fitting, 10 - 12 mm glass		981.07.280 Top pivot	

	+		+		+		<p>Combo Art. No.</p> <p>932.79.305</p> <p>Price (INR) 13,095</p> <p>5 Years Warranty</p>
932.79.020 Double cylinder floor spring 2102, 70 kg, Door width: 750 - 850 mm		981.50.010 Bottom patch fitting, 10 - 12 mm glass		981.50.020 Top patch fitting, 10 - 12 mm glass		981.07.280 Top pivot	

	+		+		+		<p>Combo Art. No.</p> <p>932.79.306</p> <p>Price (INR) 14,355</p> <p>5 Years Warranty</p>
932.79.030 Double cylinder floor spring 2103, 90 kg, Door width: 850 - 1000 mm		981.50.010 Bottom patch fitting, 10 - 12 mm glass		981.50.020 Top patch fitting, 10 - 12 mm glass		981.07.280 Top pivot	

	+		+		+		<p>Combo Art. No.</p> <p>932.79.307</p> <p>Price (INR) 15,045</p> <p>5 Years Warranty</p>
932.79.040 Double cylinder floor spring 2104, 120 kg, Door width: 1000 - 1200 mm		981.50.010 Bottom patch fitting, 10 - 12 mm glass		981.50.020 Top patch fitting, 10 - 12 mm glass		981.07.280 Top pivot	

ACCESSORIES

932.79.090



Double action top centre

Double action bottom strap

Double action accessories
Application: For wooden or aluminium framed doors
Unit of measure: SET
Price (INR): **1,205**

932.79.189 Special article**



Single action accessory
Door weight: Up to 120 kg
Unit of measure: SET
Price (INR): **7,139**

932.77.090 Special article**



Ball bearing pivot
Application: Door pivot
Glass thicknesses: 10 - 12 mm
Material: SS 304
Unit of measure: PC
Price (INR): **3,095**



Patch Fittings

PATCH FITTINGS

981.50.010



Bottom patch fitting

Application: Connects floor spring to glass door
 Max. door width: 1200 mm
 Max. door weight: 120 kg
 Glass thicknesses: 10 - 12 mm
 Material: SS 304 cover plate
 Unit of measure: PC
 Price (INR): **1,795**

981.50.020



Top patch fitting

Application: Connects top pivot to glass door
 Max. door width: 1200 mm
 Max. door weight: 120 kg
 Glass thicknesses: 10 - 12 mm
 Material: SS 304 cover plate
 Unit of measure: PC
 Price (INR): **1,795**

981.50.050



Fanlight pivot patch fitting

Application: Wall to top patch fixing
 Glass thicknesses: 10 - 12 mm
 Material: SS 304 cover plate
 Unit of measure: PC
 Price (INR): **1,835**

981.50.040



Side panel patch fitting

Application: To holds top patch glass to glass
 Glass thicknesses: 10 - 12 mm
 Material: SS 304 cover plate
 Unit of measure: PC
 Price (INR): **3,665**

981.50.030

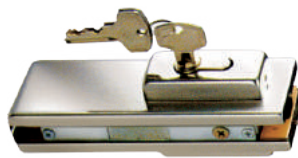

Corner patch lock with cylinder

Application: Bottom glass door lock
 Glass thicknesses: 10 - 12 mm
 Material: SS 304 cover plate
 Unit of measure: PC
 Price (INR): **3,465**

981.00.120



2 - 4 Glass panel patch

Application: To holds fixed glass panels on all 4 sides
 Glass thicknesses: 10 - 12 mm
 Material: SS 304 cover plate
 Unit of measure: PC
 Price (INR): **5,810**

981.00.060



L patch fitting

Application: L patch above glass door
 Glass thicknesses: 10 - 12 mm
 Material: SS 304 cover plate
 Unit of measure: PC
 Price (INR): **3,530**

981.07.280



Top pivot

Application: Holds top patch to wall
 Glass thicknesses: 10 - 12 mm
 Material: SS 304
 Unit of measure: PC
 Price (INR): **445**

PATCH FITTINGS

981.22.200



Single connector

Application: Connects wall and fixed glass panel

Glass thicknesses: 10 - 12 mm

Material: SS 304 cover plate

Unit of measure: PC

Price (INR): **1,375**

981.22.201



Double connector

Application: Connects wall and two fixed glass panels

Glass thicknesses: 10 - 12 mm

Material: SS 304 cover plate

Unit of measure: PC

Price (INR): **1,815**

981.07.170

Special article**



Glass clamp

Application: Connects two fixed glass panels

Glass thicknesses: 10 - 12 mm

Material: SS 304 cover plate

Unit of measure: PC

Price (INR): **1,430**

Note: **Order to stock

Pull Handles



PULL HANDLE

DOOR CONTROL
DEVICES
PATCH
FITTINGS



Startec hollow pull handle H series

Door thickness: 8 - 55 mm

Fix bolt: Ø 13 mm

Screw: M8

Application: For back to back fixing

Unit of measure: PR

PULL
HANDLES

Article No.	Finish	Diameter Ø	Overall Height	Center to Center	Price (INR)
903.11.460	Stainless steel matt + Stainless steel polished	25 mm	300 mm	220 mm	2,044
903.11.451	Stainless steel matt	25 mm	450 mm	305 mm	2,302
903.11.461	Stainless steel matt + Stainless steel polished	25 mm	450 mm	305 mm	2,201
903.11.462	Stainless steel matt + Stainless steel polished	25 mm	600 mm	450 mm	2,391
903.01.712	Stainless steel matt	25 mm	1200 mm	900 mm	6,658
903.01.715	Stainless steel matt	25 mm	1500 mm	1200 mm	9,643

PARTITION
SYSTEMS

OFFSET PIVOT
HINGES



Startec hollow pull handle D series

Fix bolt: Ø 13 mm

Screw: M8

Application: For back to back fixing

Unit of measure: PR

STILE DOOR
HARDWARE

GLASS DOOR
LOCKS

SHOWER
FITTINGS

GLASS SLIDING
SYSTEMS

Article No.	Finish	Diameter Ø	Max. Door Thickness	Center to Center	Price (INR)
903.01.601	Stainless steel matt	19 mm	50 mm	150 mm	1,383
903.01.602	Stainless steel matt	19 mm	50 mm	200 mm	1,501
903.11.470	Stainless steel matt	25 mm	55 mm	300 mm	2,397
903.11.480	Stainless steel matt + Stainless steel polished	25 mm	55 mm	300 mm	2,542
903.11.471	Stainless steel matt	25 mm	55 mm	450 mm	2,834
903.11.481	Stainless steel matt + Stainless steel polished	25 mm	55 mm	450 mm	2,845
903.11.472	Stainless steel matt	25 mm	55 mm	600 mm	3,186
903.08.610	Stainless steel matt	30 mm	50 mm	900 mm	5,516
903.08.620	Stainless steel matt	32 mm	50 mm	1200 mm	6,518

PULL HANDLE

903.00.370



Straight series

Max. door thickness: 105 mm
 Diameter Ø: 25 mm
 Center to center height: 300 mm
 Application: Back to back fixing
 Unit of measure: PR
 Price (INR): **4,424**

903.00.372

Special article**



Straight series

Max. door thickness: 50 mm
 Diameter Ø: 25 mm
 Center to center height: 400 mm
 Application: Back to back fixing
 Unit of measure: PR
 Price (INR): **5,051**

903.19.703



Que series

Application: Back to back fixing
 Max. door thickness: 50 mm
 Diameter Ø: 25 x 25 mm square
 Center to center height: 300 mm
 Unit of measure: PR
 Price (INR): **4,452**

903.09.910



Offset 45 series

Max. door thickness: 50 mm
 Diameter Ø: 25mm
 Center to center height: 300 mm
 Overall height: 500 mm
 Unit of measure: PR
 Price (INR): **5,768**



D crank series

Application: For glass and wooden doors with back to back fixing
 Material: SS 304
 Unit of measure: PR

Article No.	Finish	Diameter Ø	Overall Height	Max. Door Thickness	Price (INR)
903.09.770	Stainless steel matt	22 mm	300 mm	50 mm	3,825
903.09.790	Stainless steel matt	25 mm	400 mm	50 mm	6,311
903.09.792	Stainless steel matt	25 mm	450 mm	50 mm	7,308
903.09.800	Stainless steel matt	32 mm	600 mm	50 mm	8,333

Note: **Order to stock

A modern office interior featuring glass partition systems. The space is divided into several areas by glass walls and doors. In the foreground, a concrete pillar stands next to a glass wall. To the right, a wooden conference table is surrounded by blue chairs. In the background, an office desk with a chair is visible through the glass. The ceiling has recessed lighting and a projector. A red square overlay is positioned on the left side of the image, containing the text "Partition Systems".

Partition Systems

TWIN PRO AND U PRO

950.51.000 Special article**

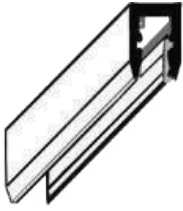

Upper glazing profile
 Application: Fixed glass partition - Top
 Glass thickness: 8 mm, 10 mm, 12 mm
 Profile length: 3000 mm
 Material: Aluminium
 Finish: Silver anodized
 Unit of measure: PC
 Price (INR): **7,500**

950.51.001 Special article**



Bottom locking profile
 Application: Fixed glass partition - Bottom
 Glass thickness: 8 mm, 10 mm, 12 mm
 Profile length: 3000 mm
 Material: Aluminium
 Finish: Silver anodized
 Unit of measure: PC
 Price (INR): **7,375**

950.51.006 Special article**

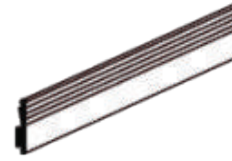

Standard gasket
 Application: Clamps glass to profile
 Glass thickness: 8 mm, 10 mm, 12 mm
 Material: EPDM gasket
 Finish: Silver anodized
 Unit of measure: Metre
 Price (INR): **390**

950.51.003 Special article**

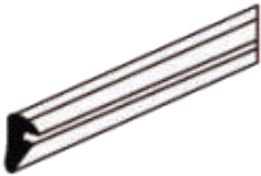

Locking gasket
 Application: Clamps glass to profile
 Glass thickness: 8 mm
 Material: EPDM gasket
 Unit of measure: Metre
 Price (INR): **315**

950.51.004 Special article**

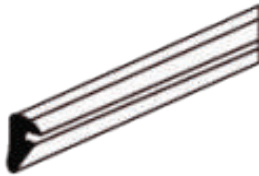

Locking gasket
 Application: Clamps glass to profile
 Glass thickness: 10 mm
 Material: EPDM gasket
 Unit of measure: Metre
 Price (INR): **200**

950.51.005 Special article**



Locking gasket
 Application: Clamps glass to profile
 Glass thickness: 12 mm
 Material: EPDM gasket
 Unit of measure: Metre
 Price (INR): **200**

RETROFIT GLASS CLAMP

981.55.050 Special article**



Application: Tabletop partition without drilling
 Glass partition thickness: 8 - 12mm
 Max. glass partition height: 762 mm (2.5 ft)
 Weight carrying capacity: 30 kg. / PR***
 SS 304 cover plate
 Tabletop thickness: 5 (min.) - 45 (max.) mm
 Rotatable: 90°
 Testing: Salt spray tested: 100 hours
 Unit of measure: PC
 Price (INR): **1,200**



*** Kindly ensure that the tabletop is sturdy enough to bear the overall weight of the glass partition assembly. Additional clamps should be installed if the glass partition weight exceeds 30 Kg.



Offset
Pivot
Hinges



OFFSET PIVOT HINGES

981.20.091 Special article**



Bottom offset pivot fitting (unhanded)

Application: Offset the glass from profile door/ rebated door
 Max. door width: 1100 mm
 Max. door weight: 100 kg
 Glass thicknesses: 8 - 12 mm
 Finish: SS Matt
 Material: SS 304
 Opening Angle: 115°
 Unit of measure: PC
 Price (INR): **21,935**



981.20.092 Special article**



Top offset pivot frame fitting (left hand)

Application: DIN Left
 Max. door width: 1100 mm
 Max. door weight: 100 kg
 Glass thicknesses: 8 - 12 mm
 Finish: SS Matt
 Material: SS 304
 Opening Angle: 115°
 Unit of measure: PC
 Price (INR): **3,960**

981.20.093 Special article**



Top offset pivot frame fitting (right hand)

Application: DIN Right
 Max. door width: 1100 mm
 Max. door weight: 100 kg
 Glass thicknesses: 8 - 12 mm
 Finish: SS Matt
 Material: SS 304
 Opening Angle: 115°
 Unit of measure: PC
 Price (INR): **3,960**



Note: **Order to stock



Stile Door Hardware

For Frameless
Glass Doors

DOOR CLOSERS

931.46.009



DCL - 87 CAM efficient door closer

Max. door width: 1100 mm
 Door weight: Up to 80 kg
 Max. opening angle: 180°
 Version: Non hold open
 EN size: 3
 Finish: Anodized aluminium
 Unit of measure: SET
 Price (INR): **21,178**

931.46.179



DCL - 87 CAM efficient door closer

Max. door width: 1100 mm
 Door weight: Up to 80 kg
 Max. opening angle: 180°
 Version: With hold open
 EN size: 3
 Finish: Anodized aluminium
 Unit of measure: SET
 Price (INR): **22,656**

931.35.001



Saddle plate for DCL - 87

For glass door thickness: 8 - 12 mm
 Material: Aluminium
 Finish: Anodized Aluminium
 Dimension (HxWxT): 204 x 55 x 8 mm
 Unit of measure: PC
 Price (INR): **4,446**

931.35.000



Drop plate for DCL - 87

Glass door thickness: 10 mm
 Material: Aluminium
 Finish: Anodized Aluminium
 Dimension (HxWxT): 204 x 55 x 10 mm
 Unit of measure: PC
 Price (INR): **3,707**

931.46.029



DCL - 88 CAM efficient door closer

Max. door width: 1100 mm
 Door weight: Up to 80 kg
 Max. opening angle: 180°
 Version: Non hold open
 EN size: 2 - 4
 Finish: Anodized aluminium
 Unit of measure: SET
 Price (INR): **22,378**

931.46.199



DCL - 88 CAM efficient door closer

Max. door width: 1100 mm
 Door weight: Up to 80 kg
 Max. opening angle: 180°
 Version: With hold open
 EN size: 2 - 4
 Finish: Anodized aluminium
 Unit of measure: SET
 Price (INR): **23,699**

931.35.003



Saddle plate for DCL - 88

Glass door thickness: 8-12 mm
 Material: Aluminium
 Finish: Anodized Aluminium
 Dimension (HxWxT): 204 x 50 x 31 mm
 Unit of measure: PC
 Price (INR): **4,368**

931.35.002



Drop plate for DCL - 88

Glass door thickness: 10 mm
 Material: Aluminium
 Finish: Anodized Aluminium
 Dimension (HxWxT): 239 x 55 x 10 mm
 Unit of measure: PC
 Price (INR): **3,914**

931.46.049

Special article**



DCL - 89 CAM efficient door closer

Max. door width: 1250 mm
 Door weight: Up to 120 kg
 Max. opening angle: 180°
 Version: Non hold open
 EN size: 2- 5
 Finish: Anodized aluminium
 Unit of measure: SET
 Price (INR): **25,598**

Note: **Order to stock

DOOR CLOSERS

931.46.219



DCL - 89 CAM efficient door closer

Max. door width: 1250 mm
 Door weight: Up to 120 kg
 Max. opening angle: 120°
 Version: With hold open
 EN size: 2 - 5
 Finish: Anodized
 Unit of measure: SET
 Price (INR): **28,235**

931.35.005



Saddle plate for DCL - 89

Glass door thickness: 8 - 12 mm
 Material: Aluminium
 Finish: Anodized Aluminium
 Dimension (HxWxT):
 205 x 50 x 31 mm
 Unit of measure: PC
 Price (INR): **4,368**

931.35.004



Patch plate for DCL - 89

Glass door thickness: 8 mm
 Material: Aluminium
 Finish: Anodized Aluminium
 Dimension (HxWxT):
 255 x 60 x 10 mm
 Unit of measure: PC
 Price (INR): **3,914**



DOOR CONTROL DEVICES
 PATCH FITTINGS
 PULL HANDLES
 PARTITION SYSTEMS
 OFFSET PIVOT HINGES
STILE DOOR HARDWARE
 GLASS DOOR LOCKS
 SHOWER FITTINGS
 GLASS SLIDING SYSTEMS

HINGES

981.75.020



Linear square hinge

Application: Profile hinge for frameless glass door
 Glass thickness: 8 - 12 mm
 Finish: SS Matt
 Material: SS 304
 Unit of measure: PC
 Price (INR): **4,180**

981.78.400



Linear square hinge

Application: Profile hinge for frameless glass door
 Glass thickness: 8 - 12 mm
 Finish: Aluminium
 Material: Aluminium
 Unit of measure: PC
 Price (INR): **3,035**

981.75.010



Arc round hinge

Application: Profile hinge for frameless glass door
 Glass thickness: 8 - 12 mm
 Finish: SS Matt
 Material: SS 304
 Unit of measure: PC
 Price (INR): **4,180**

981.78.401



Arc round hinge

Application: Profile hinge for frameless glass door
 Glass thickness: 8 - 12 mm
 Finish: Aluminium
 Material: Aluminium
 Unit of measure: PC
 Price (INR): **3,035**

981.50.161

Special article**



Curved glass door hinge

Application: Profile hinge for frameless glass door
 Glass thickness: 8 - 12 mm
 Finish: SS Grade 304
 Material: SS 304
 Unit of measure: PC
 Price (INR): **5,115**



LOCKS AND HANDLES

981.50.170

Special article**



Square glass door lock with handle - Linear series

Application: Profile lock for a frameless glass door

Glass thickness: 8 - 12 mm

Finish: SS Matt

Material: SS 304

Unit of measure: PC

Price (INR): **11,225**

981.50.175

Special article**



Square strike patch - Linear series

Application: Strike plate for rebated glass door

Glass thickness: 8 - 12 mm

Finish: SS Matt

Unit of measure: PC

Price (INR): **4,200**

981.50.171

Special article**



Curved glass door lock with handle - Linear series

Application: Rebated frameless glass door lock

Glass thickness: 8 - 12 mm

Finish: SS Matt

Unit of measure: PC

Price (INR): **10,920**

981.50.176

Special article**



Curved strike patch - Linear series

Application: Strike patch for rebated glass door

Glass thickness: 8 - 12 mm

Finish: SS Matt

Unit of measure: PC

Price (INR): **3,475**

981.78.402

Special article**



Square glass door lock without handle - Linear series

Application: Rebated glass door lock for frameless profile

Glass thickness: 8 - 12 mm

Finish: Aluminium

Material: Aluminium

Unit of measure: PC

Price (INR): **8,315**

981.78.404

Special article**



Square glass door strike plate - Linear series

Application: Strike plate for rebated frameless glass door

Glass thickness: 8 - 12 mm

Finish: Aluminium

Unit of measure: PC

Price (INR): **3,685**

DOOR CONTROL DEVICES
PATCH FITTINGS
PULL HANDLES
PARTITION SYSTEMS
OFFSET PIVOT HINGES
STILE DOOR HARDWARE
GLASS DOOR LOCKS
SHOWER FITTINGS
GLASS SLIDING SYSTEMS

981.78.406



Curved lock without handle - Arc series

Application: Rebated frameless glass door lock
 Glass thickness: 8 - 12 mm
 Finish: Aluminium
 Material: Aluminium
 Unit of measure: PC
 Price (INR): **8,500**

981.78.409

Special article**



Curved strike patch - Arc series

Application: Strike patch for glass rebated door lock
 Glass thickness: 8 - 12 mm
 Finish: Aluminium
 Unit of measure: PC
 Price (INR): **3,145**

981.78.403

Special article**



Lever handles - L Square

Application: Handle for rebated glass door lock
 Finish: Aluminium
 Material: Aluminium
 Unit of measure: PR
 Price (INR): **2,100**

981.78.408



Lever handles - D round

Application: Handle for rebated glass door lock
 Finish: Aluminium
 Material: Aluminium
 Unit of measure: PR
 Price (INR): **2,100**

981.78.407



Lever handles - L round

Application: Handle for rebated glass door lock
 Finish: Aluminium
 Material: Aluminium
 Unit of measure: PR
 Price (INR): **1,850**

981.78.405



Strike plate for timber door

Application: Strike plate on profile
 Finish: SS Matt
 Material: SS 304
 Unit of measure: PC
 Price (INR): **420**

Black Stile Door Hardware



BLACK FRAMELESS STILE DOOR

981.78.454



Round glass door hinge

Application: Profile door hinge for frameless door
 Glass thickness: 8 - 12 mm
 Max. door weight: 30 - 90 kg
 Max. door width: 600 - 1000 mm
 Finish: Black
 Unit of measure: PC
 Price (INR): **2,805**

981.78.456



Round glass door lock without lever handle

Application: Rebated glass door lock
 Glass thickness: 8 - 12 mm
 Finish: Black
 Unit of measure: PC
 Price (INR): **6,710**

981.78.457



Strike patch

Application: Strike plate for rebated glass door lock
 Glass thickness: 8 - 12 mm
 Finish: Black
 Unit of measure: PC
 Price (INR): **3,540**

916.64.281



Euro profile cylinders

Application: Cylinder for round glass door lock
 Size: 70 mm
 Finish: Black
 Keys: 3
 Unit of measure: PC
 Price (INR): **1,523**

981.78.455



Lever handle - D round

Application: Handle for round glass door lock
 Finish: Black
 Unit of measure: PC
 Price (INR): **2,310**

981.78.453

Special article**



Strike plate

Application: Strike plate for profile/timber door
 Finish: Black
 Unit of measure: PC
 Price (INR): **360**

931.77.003



DCL 301- Black door closer

Application: Rack and pinion surface mounted door closer
 Max. door width: 950 - 1000 mm
 Door weight: Up to 60 kg
 Max. opening angle: 180°
 Hold open angle: Adjustable
 EN size: 3
 Finish: Black
 Unit of measure: PC
 Price (INR): **11,066**

931.39.603



DCL 301- Black saddle plate (For framless glass door)

Application: To connect glass to the door closer
 Glass door thickness: 8 - 12 mm
 Finish: Black
 Dimension (HxWxT): 205 x 50 x 31 mm
 Unit of measure: PC
 Price (INR): **3,472**

931.77.153



Drop plate black

(For framed glass door)
 Application: To offset saddle plate
 Glass door thickness: 10 mm
 Finish: Black
 Dimension (HxWxT): 203 x 55 x 10 mm
 Unit of measure: PC
 Price (INR): **2,520**

A photograph of a glass door with a lock and handle, set against a background of horizontal blinds. The door is partially open, and the lock mechanism is visible. The handle is a sleek, modern design. The blinds are white with horizontal slats. The overall scene is brightly lit, suggesting an office or modern building interior.

Glass Door Locks

SLIDING DOOR LOCKS

911.26.202

Special article**



Sliding door lock

Glass thickness: 10 - 12 mm
 Finish: Chrome polished
 Material: Brass
 Unit of measure: PC
 Price (INR): **11,275**

911.26.212

Special article**



Strike box

Glass thickness: 10 - 12 mm
 Finish: Chrome polished
 Material: Brass
 Unit of measure: PC
 Price (INR): **10,360**

INDICATOR BATHROOM LOCKS

911.12.045



Outside Inside

WC Indicator lock

Application: For single panel glass door
 Glass thickness: 8 - 10 mm
 Finish: Chrome polished
 Material: Brass
 Unit of measure: PC
 Price (INR): **7,020**

911.12.046

Special article**



Outside Inside

WC Indicator lock

Application: For single panel glass door
 Glass thickness: 8 - 10 mm
 Finish: Satin chrome polished
 Material: Brass
 Unit of measure: PC
 Price (INR): **7,055**

911.12.047



Outside Inside

WC Indicator lock with strike box

Application: Glass to glass (for application with fixed glass panel)
 Glass thickness: 8 - 10 mm
 Finish: Chrome polished
 Material: Brass
 Unit of measure: PC
 Price (INR): **7,760**

911.12.048

Special article**



Outside Inside

WC Indicator lock with strike box

Application: Glass to glass (for application with fixed glass panel)
 Glass thickness: 8 - 10 mm
 Finish: Satin chrome polished
 Material: Brass
 Unit of measure: PC
 Price (INR): **8,185**

Note: **Order to stock

LOCKS WITHOUT CUT-OUT REQUIREMENTS

DOOR CONTROL DEVICES
PATCH FITTINGS
PULL HANDLES
PARTITION SYSTEMS
OFFSET PIVOT HINGES
STILLE DOOR HARDWARE
GLASS DOOR LOCKS
SHOWER FITTINGS
GLASS SLIDING SYSTEMS

981.42.902



Outside

Inside

Indicator lock

Application: For bathroom with indicator (Glass door to wall)
Glass thickness: 8 - 12 mm
Finish: Chrome polished
Material: Brass
Unit of measure: PC
Price (INR): **7,730**

981.42.906

Special article**



Outside

Inside

Indicator lock

Application: For bathroom with indicator (Glass door with wall)
Glass thickness: 8 - 12 mm
Finish: Nickel matt finished
Material: Brass
Unit of measure: PC
Price (INR): **7,730**

981.42.912



Indicator lock with strike box

Application: Glass to glass (for application with fixed glass panel)
Glass thickness: 8 - 12 mm
Finish: Chrome polished
Material: Brass
Unit of measure: PC
Price (INR): **10,330**

981.42.916

Special article**



Indicator lock with strike box

Application: Glass to glass (for application with fixed glass panel)
Glass thickness: 8 - 12 mm
Finish: Nickel Matt
Base material: Brass
Unit of measure: PC
Price (INR): **10,330**

981.07.320



Side mounted deadbolt

Glass thickness: 10- 12 mm
Finish: Chrome polished
Base material: Brass
Unit of measure: PC
Price (INR): **1,910**

981.07.336



Strike box for 981.07.320

Glass thickness: 10-12 mm
Finish: Chrome polished
Base material: Brass
Unit of measure: PC
Price (INR): **1,660**

981.52.540

Special article**



Curved latch lock

Application: Glass to glass (for application with fixed glass panel)
Glass thickness: 8 - 12 mm
Cylinder: Keyed on both sides
Finish: SS Matt
Unit of measure: PC
Price (INR): **2,865**

981.52.550

Special article**



Curved latch lock with strike box

Application: Lock for glass door with fixed glass panel
Glass thickness: 8 - 12 mm
Cylinder: Keyed on both sides
Finish: SS Matt
Unit of measure: PC
Price (INR): **3,610**

Shower Fittings



SHOWER HINGES - Kaaza Series

DOOR CONTROL DEVICES
PATCH FITTINGS
PULL HANDLES
PARTITION SYSTEMS
OFFSET PIVOT HINGES
STILE DOOR HARDWARE
GLASS DOOR LOCKS
SHOWER FITTINGS
GLASS SLIDING SYSTEMS

981.55.060



7
Years
Warranty

Wall to glass fixed clamp

Glass thickness: 8 - 12 mm
Finish: SS Matt
Material: SS 304
Tested for 100,000 cycles*
Tested: EN 11428 - Salt spray tested
Unit of measure: PC
Price (INR): **2,520**

981.55.061



7
Years
Warranty

Wall to glass fixed clamp

Glass thickness: 8 - 12 mm
Finish: SS polished
Material: SS 304
Tested for 100,000 cycles*
Tested: EN 11428 - Salt spray tested
Unit of measure: PC
Price (INR): **2,520**

981.55.070



7
Years
Warranty

Wall to glass hinge 180°

Glass thickness: 8 - 12 mm
Max. door width: 900 mm
Max. door weight: 45 kg for 2 hinges
Material: SS 304
Tested for 100,000 cycles*
Tested: EN 11428 - Salt spray tested
Unit of measure: PC
Price (INR): **2,625**

981.55.071



7
Years
Warranty

Wall to glass hinge 180°

Glass thickness: 8 - 12 mm
Max. door width: 900 mm
Max. door weight: 45 kg for 2 hinges
Finish: SS polished
Material: SS 304
Tested for 100,000 cycles*
Tested: EN 11428- Salt spray tested
Unit of measure: PC
Price (INR): **2,625**

981.55.068



7
Years
Warranty

Wall to glass hinge 90°

Glass thickness: 8 - 12 mm
Max. door width: 900 mm
Max. door weight: 45 kg for 2 hinges
Finish: SS Matt
Material: SS 304
Tested for 100,000 cycles*
Tested: EN 11428- Salt spray tested
Unit of measure: PC
Price (INR): **3,045**

981.55.069



7
Years
Warranty

Wall to glass hinge 90°

Glass thickness: 8 - 12 mm
Max. door width: 900 mm
Max. door weight: 45 kg for 2 hinges
Finish: SS Polished
Material: SS 304
Tested for 100,000 cycles*
Tested: EN 11428- Salt spray tested
Unit of measure: PC
Price (INR): **3,045**

981.55.064



7
Years
Warranty

Glass to glass hinge 135°

Glass thickness: 8 - 12 mm
Max. door width: 900 mm
Max. door weight: 45 kg for 2 hinges
Finish: SS Matt
Material: SS 304
Tested for 100,000 cycles*
Tested: EN 11428 - Salt spray tested
Unit of measure: PC
Price (INR): **4,380**

981.55.065



7
Years
Warranty

Glass to glass hinge 135°

Glass thickness: 8 - 12 mm
Max. door width: 900 mm
Max. door weight: 45 kg for 2 hinges
Finish: SS polished
Material: SS 304
Tested for 100,000 cycles*
Tested: EN 11428 - Salt spray tested
Unit of measure: PC
Price (INR): **4,380**

981.55.066



7
Years
Warranty

Glass to glass hinge 180°

Glass thickness: 8 - 12 mm
Max. door width: 900 mm
Max. door weight: 45 kg for 2 hinges
Finish: SS Matt
Material: SS 304
Tested for 100,000 cycles*
Tested: EN 11428 - Salt spray tested
Unit of measure: PC
Price (INR): **4,100**

Note: *Hafele internal testing

SHOWER HINGES - Kaaza Series

981.55.067



7 Years Warranty

Glass to glass hinge 180°

Glass thickness: 8 - 12 mm
 Max. door width: 900 mm
 Max. door weight: 45 kg for 2 hinges
 Finish: SS polished
 Material: SS 304
 Tested for 100,000 cycles*
 Tested: EN 11428 - Salt spray tested
 Unit of measure: PC
 Price (INR): **4,100**

981.55.062



7 Years Warranty

Glass to glass hinge 90°

Glass thickness: 8 - 12 mm
 Max. door width: 900 mm
 Max. door weight: 45 kg for 2 hinges
 Finish: SS Matt
 Material: SS 304
 Tested for 100,000 cycles*
 Tested: EN 11428 - Salt spray tested
 Unit of measure: PC
 Price (INR): **4,595**

981.55.063



7 Years Warranty

Glass to glass hinge 90°

Glass thickness: 8 - 12 mm
 Max. door width: 900 mm
 Max. door weight: 45 kg for 2 hinges
 Finish: SS Polished
 Material: SS 304
 Tested for 100,000 cycles*
 Tested: EN 11428 - Salt spray tested
 Unit of measure: PC
 Price (INR): **4,595**

981.09.090

Special article**



3-way shower hinge

Application: For 2 separate frameless glass doors and one fixed glass partition
 Glass thickness: 8 - 10 mm
 Max. door width: 900 mm
 Max. door weight: 45 kg for 2 hinges
 Finish: SS polished
 Material: SS 304
 Tested for 100,000 cycles*
 Unit of measure: PC
 Price (INR): **16,585**

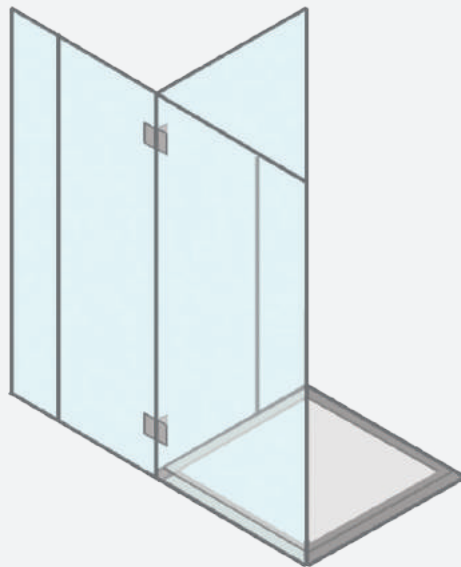

489.02.701

Special article**



Glass to glass hinge 180°

Application: Spring action hinges for soft close mechanism
 Glass thickness: 8 - 12 mm
 Max. door width: 900 mm
 Max. door weight: 45 kg for 2 hinges
 Finish: SS polished
 Material: SS 304
 Tested for 100,000 cycles*
 Unit of measure: PC
 Price (INR): **25,680**

489.02.700

Special article**



Wall to glass hinge 180°

Application: Spring action hinges for soft close mechanism
 Glass thickness: 8 - 12 mm
 Max. door width: 900 mm
 Max. door weight: 45 kg for 2 hinges
 Finish: SS polished
 Material: SS 304
 Unit of measure: PC
 Price (INR): **24,075**



Note: *Hafele internal testing

SHOWER HINGES - Bellini Series

DOOR CONTROL DEVICES
PATCH FITTINGS
PULL HANDLES
PARTITION SYSTEMS
OFFSET PIVOT HINGES
STILE DOOR HARDWARE
GLASS DOOR LOCKS
SHOWER FITTINGS
GLASS SLIDING SYSTEMS

981.35.222

Special article**



Wall to glass fix clamp

Glass thickness: 8 - 10 mm
Finish: Chrome polished
Material: Brass
Unit of measure: PC
Price (INR): **3,425**

981.35.226

Special article**



Wall to glass fix clamp

Glass thickness: 8 - 10 mm
Finish: Nickel matt
Material: Brass
Unit of measure: PC
Price (INR): **3,620**

981.35.002

Special article**



Wall to glass hinge 180°

Glass thickness: 8 - 10 mm
Door width: 800 mm
Door weight: 35 kg/ Set
Finish: Chrome polished
Material: Brass
Unit of measure: PC
Price (INR): **4,930**

981.35.006

Special article**



Wall to glass hinge 180°

Glass thickness: 8 - 10 mm
Door width: 800 mm
Door weight: 35 kg/ Set
Finish: Nickel matt
Material: Brass
Unit of measure: PC
Price (INR): **5,400**

981.35.012

Special article**



Wall to glass hinge 90°

Glass thickness: 8 - 10 mm
Door width: 800 mm
Door weight: 35 kg/ Set
Finish: Chrome polished
Material: Brass
Unit of measure: PC
Price (INR): **4,930**

981.35.016

Special article**



Wall to glass hinge 90°

Glass thickness: 8 - 10 mm
Door width: 800 mm
Door weight: 35 kg/ Set
Finish: Nickel matt
Material: Brass
Unit of measure: PC
Price (INR): **5,400**

981.35.032

Special article**



Glass to glass hinge 135°

Glass thickness: 8 - 10 mm
Door width: 800 mm
Door weight: 35 kg/ Set
Finish: Chrome polished
Material: Brass
Unit of measure: PC
Price (INR): **7,880**

981.35.022

Special article**



Glass to glass hinge 180°

Glass thickness: 8 - 10 mm
Door width: 800 mm
Door weight: 35 kg/ Set
Finish: Chrome polished
Material: Brass
Unit of measure: PC
Price (INR): **6,665**

981.35.026

Special article**



Glass to glass hinge 180°

Glass thickness: 8 - 10 mm
Door width: 800 mm
Door weight: 35 kg/ Set
Finish: Nickel matt
Material: Brass
Unit of measure: PC
Price (INR): **7,880**

Note: **Order to stock

SHOWER HINGES - Bellini Series

981.35.042

Special article**



Glass to glass hinge 90°
 Glass thickness: 8 - 10 mm
 Door width: 800 mm
 Door weight: 35 kg/ Set
 Finish: Chrome polished
 Material: Brass
 Unit of measure: PC
 Price (INR): **7,880**

981.35.046

Special article**



Glass to glass hinge 90°
 Glass thickness: 8 - 10 mm
 Door width: 800 mm
 Door weight: 35 kg/ Set
 Finish: Nickel matt
 Material: Brass
 Unit of measure: PC
 Price (INR): **7,880**



SHOWER HINGES - Alda Series

DOOR CONTROL DEVICES
PATCH FITTINGS
PULL HANDLES
PARTITION SYSTEMS
OFFSET PIVOT HINGES
STILE DOOR HARDWARE
GLASS DOOR LOCKS
SHOWER FITTINGS
GLASS SLIDING SYSTEMS

981.35.232



Wall to glass fix clamp
Glass thickness: 8 - 10 mm
Finish: Chrome polished
Material: Brass
Unit of measure: PC
Price (INR): **3,425**

981.35.052



Wall to glass hinge 180°
Glass thickness: 8 - 10 mm
Max door width: Up to 800 mm
Max door weight: 35 kg for 2 hinges
Finish: Chrome polished
Material: Brass
Unit of measure: PC
Price (INR): **4,345**

981.35.056



Wall to glass hinge 180°
Glass thickness: 8 - 10 mm
Max door width: Up to 800 mm
Max door weight: 35 kg for 2 hinges
Finish: Nickel matt
Material: Brass
Unit of measure: PC
Price (INR): **4,710**

981.35.062



Wall to glass hinge 90°
Glass thickness: 8 - 10 mm
Max door width: Up to 800 mm
Max door weight: 35 kg for 2 hinges
Finish: Chrome polished
Material: Brass
Unit of measure: PC
Price (INR): **4,345**

981.35.066



Wall to glass hinge 90°
Glass thickness: 8 - 10 mm
Max door width: Up to 800 mm
Max door weight: 35 kg for 2 hinges
Finish: Nickel matt
Material: Brass
Unit of measure: PC
Price (INR): **4,710**

981.35.082

Special article**



Glass to glass hinge 135°
Glass thickness: 8 - 10 mm
Max door width: Up to 800 mm
Max door weight: 35 kg for 2 hinges
Finish: Chrome polished
Material: Brass
Unit of measure: PC
Price (INR): **7,220**

981.35.086

Special article**



Glass to glass hinge 135°
Glass thickness: 8 - 10 mm
Max door width: Up to 800 mm
Max door weight: 35 kg for 2 hinges
Finish: Nickel matt
Material: Brass
Unit of measure: PC
Price (INR): **7,765**

981.35.072



Glass to glass hinge 180°
Glass thickness: 8 - 10 mm
Max door width: Up to 800 mm
Max door weight: 35 kg for 2 hinges
Finish: Chrome polished
Material: Brass
Unit of measure: PC
Price (INR): **7,220**

981.35.076



Glass to glass hinge 180°
Glass thickness: 8 - 10 mm
Max door width: Up to 800 mm
Max door weight: 35 kg for 2 hinges
Finish: Nickel matt
Material: Brass
Unit of measure: PC
Price (INR): **7,765**

SHOWER HINGES - Alda Series

981.35.092



Glass to glass hinge 90°

Glass thickness: 8 - 10 mm
 Max door width: Up to 800 mm
 Max door weight: 35 kg for 2 hinges
 Finish: Chrome polished
 Material: Brass
 Unit of measure: PC
 Price (INR): **7,220**

981.35.096



Glass to glass hinge 90°

Glass thickness: 8 - 10 mm
 Max door width: Up to 800 mm
 Max door weight: 35 kg for 2 hinges
 Finish: Nickel matt
 Material: Brass
 Unit of measure: PC
 Price (INR): **7,765**

CONNECTORS - Curved Series

981.55.072



7 Years
Warranty

Floor to glass 90°

Glass thickness: 8 - 12 mm
 Finish: SS matt
 Material: SS 304
 Tested to EN 11428
 Salt spray tested: 96 hours
 Unit of measure: PC
 Price (INR): **460**

981.55.073



7 Years
Warranty

Floor to glass 90°

Glass thickness: 8 - 12 mm
 Finish: SS polished
 Material: SS 304
 Tested to EN 11428
 Salt spray tested: 96 hours
 Unit of measure: PC
 Price (INR): **460**

981.55.074



7 Years
Warranty

Wall to glass 90°

Glass thickness: 8 - 12 mm
 Finish: SS matt
 Material: SS 304
 Tested to EN 11428
 Salt spray tested: 96 hours
 Unit of measure: PC
 Price (INR): **595**

981.55.075



7 Years
Warranty

Wall to glass 90°

Glass thickness: 8 - 12 mm
 Finish: SS polished
 Material: SS 304
 Tested to EN 11428
 Salt spray tested: 96 hours
 Unit of measure: PC
 Price (INR): **595**

981.55.076



7 Years
Warranty

Glass to glass 90°

Glass thickness: 8 - 12 mm
 Finish: SS matt
 Material: SS 304
 Tested to EN 11428
 Salt spray tested: 96 hours
 Unit of measure: PC
 Price (INR): **915**

981.55.077



7 Years
Warranty

Glass to glass 90°

Glass thickness: 8 - 12 mm
 Finish: SS polished
 Material: SS 304
 Tested to EN 11428
 Salt spray tested: 96 hours
 Unit of measure: PC
 Price (INR): **965**

CONNECTORS - Curved Series

981.55.078



7 Years
Warranty

Glass to glass 180°

Glass thickness: 8 - 12 mm
Finish: SS matt
Material: SS 304
Tested to EN 11428
Salt spray tested: 96 hours
Unit of measure: PC
Price (INR): **960**

981.55.079



7 Years
Warranty

Glass to glass 180°

Glass thickness: 8 - 12 mm
Finish: SS polished
Material: SS 304
Tested to EN 11428
Salt spray tested: 96 hours
Unit of measure: PC
Price (INR): **980**

981.55.080



7 Years
Warranty

Glass to glass 135°

Glass thickness: 8 - 12 mm
Finish: SS matt
Material: SS 304
Tested to EN 11428
Salt spray tested: 96 hours
Unit of measure: PC
Price (INR): **960**

981.55.081



7 Years
Warranty

Glass to glass 135°

Glass thickness: 8 - 12 mm
Finish: SS polished
Material: SS 304
Tested to EN 11428
Salt spray tested: 96 hours
Unit of measure: PC
Price (INR): **980**

CONNECTORS - Straight Series

981.20.230



Floor to glass 90°

Glass thickness: 8 - 12 mm
Finish: SS matt
Material: SS 304
Unit of measure: PC
Price (INR): **740**

981.20.231



Wall to glass 90°

Glass thickness: 8 - 12 mm
Finish: SS polished
Material: SS 304
Unit of measure: PC
Price (INR): **740**

981.20.240



Wall to glass 90°

Glass thickness: 8 - 12 mm
Finish: SS matt
Material: SS 304
Unit of measure: PC
Price (INR): **870**

CONNECTORS - Straight Series

981.20.241



Wall to glass 90°
 Glass thickness: 8 - 12 mm
 Finish: SS polished
 Material: SS 304
 Unit of measure: PC
 Price (INR): **870**

981.20.250

Special article**

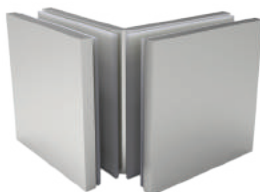

Glass to glass 90°
 Glass thickness: 8 - 12 mm
 Finish: SS matt
 Material: SS 304
 Unit of measure: PC
 Price (INR): **1,065**

981.20.251

Special article**

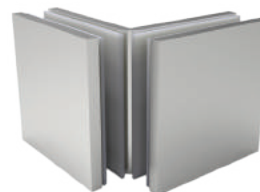

Glass to glass 90°
 Glass thickness: 8 - 12 mm
 Finish: SS polished
 Material: SS 304
 Unit of measure: PC
 Price (INR): **1,100**

981.20.260

Special article**



Glass to glass 180°
 Glass thickness: 8 - 12 mm
 Finish: SS matt
 Material: SS 304
 Unit of measure: PC
 Price (INR): **1,210**

981.20.261

Special article**



Glass to glass 180°
 Glass thickness: 8 - 12 mm
 Finish: SS polished
 Material: SS 304
 Unit of measure: PC
 Price (INR): **1,240**

981.20.270

Special article**



Glass to glass 135°
 Glass thickness: 8 - 12 mm
 Finish: SS matt
 Material: SS 304
 Unit of measure: PC
 Price (INR): **1,210**

981.20.271

Special article**



Wall to glass 135°
 Glass thickness: 8 - 12 mm
 Finish: SS polished
 Material: SS 304
 Unit of measure: PC
 Price (INR): **1,240**

CONNECTORS - Brass Curved Series

981.35.142

Special article**



Glass to glass bracket 90°

Glass thickness: 8 - 10 mm

Finish: Chrome polished

Material: Brass

Unit of measure: PC

Price (INR): **2,130**

981.35.122

Special article**



Glass to glass bracket 180°

Glass thickness: 8 - 10 mm

Finish: Chrome polished

Material: Brass

Unit of measure: PC

Price (INR): **2,355**

981.35.126

Special article**



Glass to glass bracket 180°

Glass thickness: 8 - 12 mm

Finish: Nickel matt

Material: Brass

Unit of measure: PC

Price (INR): **2,495**

981.35.112

Special article**



Wall to glass 90°

Glass thickness: 8 - 10 mm

Finish: Chrome polished

Material: Brass

Unit of measure: PC

Price (INR): **1,700**

981.35.116

Special article**



Wall to glass 90°

Glass thickness: 8 - 10 mm

Finish: Nickel matt

Material: Brass

Unit of measure: PC

Price (INR): **1,775**

981.35.102

Special article**



Floor to glass 90°

Glass thickness: 8 - 10 mm

Finish: Chrome polished

Material: Brass

Unit of measure: PC

Price (INR): **1,430**

981.35.106

Special article**



Floor to glass 90°

Glass thickness: 8 - 10 mm

Finish: Nickel matt

Material: Brass

Unit of measure: PC

Price (INR): **1,515**

SHOWER HANDLES



983.13.040



7 Years Warranty

19 mm towel bar with pull handle

Finish: SS matt
 Material: SS 304
 Towel bar size (mm): 19 x 450
 Pull handle size (mm): 19 x 200
 Tested to EN 11428
 Salt spray tested: 96 hours
 Unit of measure: PR
 Price (INR): **3,160**

983.13.041



7 Years Warranty

19 mm towel bar with pull handle

Finish: SS polished
 Material: SS 304
 Towel bar size (mm): 19 x 450
 Pull handle size (mm): 19 x 200
 Tested to EN 11428
 Salt spray tested: 96 hours
 Unit of measure: PR
 Price (INR): **3,160**

983.13.050



7 Years Warranty

25 mm towel bar with pull handle

Finish: SS matt
 Material: SS 304
 Towel bar size (mm): 25 x 450
 Pull handle size (mm): 25 x 200
 Tested to EN 11428
 Salt spray tested: 96 hours
 Unit of measure: PR
 Price (INR): **3,905**

983.13.051



7 Years Warranty

25 mm towel bar with pull handle

Finish: SS polished
 Material: SS 304
 Towel bar size (mm): 25 x 450
 Pull handle size (mm): 25 x 200
 Tested to EN 11428
 Salt spray tested: 96 hours
 Unit of measure: PR
 Price (INR): **3,905**

983.13.010

Special article**



7 Years Warranty

19 mm towel bar with pull knob

Finish: SS matt
 Material: SS 304
 Towel bar size (mm): 19 x 450
 Tested to EN 11428
 Salt spray tested: 96 hours
 Unit of measure: PR
 Price (INR): **2,605**

983.13.061



7 Years Warranty

19 mm towel bar with pull knob

Finish: SS polished
 Material: SS 304
 Towel bar size (mm): 19 x 450
 Tested to EN 11428
 Salt spray tested: 96 hours
 Unit of measure: PR
 Price (INR): **4,130**

Note: **Order to stock

SHOWER HANDLES

980.47.010

Special article**



25 mm towel bar with knob

Finish: SS matt

Material: SS 304

Towel bar size (mm): 25 x 450

Unit of measure: PR

Price (INR): **3,860**

983.13.061



25 mm towel bar with knob

Finish: SS polished

Material: SS 304

Towel bar size (mm): 25 x 450

Unit of measure: PR

Price (INR): **4,130**

903.01.993

Special article**



25 mm towel bar with knob

Finish: SS polished

Material: SS 304

Towel bar size (mm): 25 x 450

Pull handle size (mm): 25 x 200

Unit of measure: PR

Price (INR): **6,955**

981.53.282

Special article**



25 mm towel bar with knob

Finish: SS polished

Material: SS 304

Towel bar size (mm): 25 x 450

Unit of measure: PR

Price (INR): **4,570**

981.20.210

Special article**



25 mm towel bar with knob

Finish: SS matt

Material: SS 304

Towel bar size (mm): 25 x 10 x 465

Knob square: 32 x 25 mm

Unit of measure: PR

Price (INR): **8,630**

981.20.211

Special article**



25 mm towel bar with knob

Finish: SS polished

Material: SS 304

Towel bar size (mm): 25 x 10 x 465

Knob square: 32 x 25 mm

Unit of measure: PR

Price (INR): **9,500**

981.20.200

Special article**



25 mm towel bar with knob

Finish: SS matt

Material: SS 304

Towel bar size (mm):

25 x 12.70 x 450

Knob square: 35 x 32 mm

Unit of measure: PR

Price (INR): **6,400**

981.20.201

Special article**



25 mm towel bar with knob

Finish: SS polished

Material: SS 304

Towel bar size (mm):

25 x 12.70 x 450

Knob square: 35 x 32 mm

Unit of measure: PR

Price (INR): **6,740**

SHOWER HEADER BARS - Round Series

981.20.500



Wall support

Application: Supports the header bar and connects it to the wall
 Diameter: 19 mm
 Finish: SS matt
 Material: SS 304
 Salt spray tested: 96 hours
 Unit of measure: PC
 Price (INR): **925**

981.20.151



Wall support

Application: Supports the header bar and connects it to the wall
 Diameter: 19 mm
 Finish: SS polished
 Material: SS 304
 Salt spray tested: 96 hours
 Unit of measure: PC
 Price (INR): **1,070**

981.20.510

Special article**



End support

Application: Glass end support for header bar
 Diameter: 19 mm
 Finish: SS matt
 Material: SS 304
 Salt spray tested: 96 hours
 Unit of measure: PC
 Price (INR): **1,625**

981.20.161

Special article**



End support

Application: Glass end support for header bar
 Diameter: 19 mm
 Finish: SS polished
 Material: SS 304
 Salt spray tested: 96 hours
 Unit of measure: PC
 Price (INR): **1,680**

981.20.520



Middle support

Application: Middle support for header bar, clamps onto fixed glass
 Finish: SS matt
 Material: SS 304
 Salt spray tested: 96 hours
 Unit of measure: PC
 Price (INR): **1,365**

981.20.171



Middle support

Application: Middle support for header bar, clamps onto fixed glass
 Finish: SS polished
 Material: SS 304
 Salt spray tested: 96 hours
 Unit of measure: PC
 Price (INR): **1,365**

981.52.141



Shower rail connector

Application: To connect 2 header bars
 Diameter: 19 mm
 Finish: SS polished
 Material: SS 304
 Salt spray tested: 96 hours
 Unit of measure: PC
 Price (INR): **1,555**

981.52.161



T shower rail connector

Application: To connect 3 header bars
 Diameter: 19 mm
 Finish: SS polished
 Material: SS 304
 Salt spray tested: 96 hours
 Unit of measure: PC
 Price (INR): **1,390**

Note: **Order to stock

SHOWER HEADER BARS - Round Series



Header bar

Application: Rod for connecting fixed glass from top

Diameter: 19 mm

Sheet thickness: 1.2 mm

Finish: SS polished

Material: SS 304

Unit of measure: PC

Article No.	Finish	Size	Price (INR)
981.20.612 Special article**	Stainless steel matt	1200 mm	1,665
981.20.194	Stainless steel polished	1200 mm	1,680
981.20.191	Stainless steel matt	2000 mm	2,380
981.20.193	Stainless steel polished	2000 mm	2,510
981.20.190	Stainless steel matt	3000 mm	3,380
981.20.192	Stainless steel polished	3000 mm	3,455

SHOWER SEALS



Wall seal

Application: To seal double action door and wall

Material: PVC

Unit of measure: PC

Article No.	Glass size	Size	Price (INR)
950.28.200	8 mm	2500 mm	330
950.28.201	10 mm	2500 mm	330
950.28.202	12 mm	2500 mm	360



Weather seal

Application: To seal the gap between door and side panel opposite the hinge

Material: PVC

Unit of measure: PC

Article No.	Glass size	Size	Price (INR)
950.28.203	8 mm	2500 mm	330
950.28.204	10 mm	2500 mm	330
950.28.205	12 mm	2500 mm	360



Sliding seal

Special article**

Application: To seal gap between fixed panel and shutter gap

Material: PVC

Unit of measure: PC

Article No.	Glass size	Size	Price (INR)
950.50.406	8 mm	2400 mm	330
950.50.407	10 mm	2400 mm	330
950.50.408	12 mm	2400 mm	360

SHOWER SEALS



Bottom seal

Application: Bottom seal with water run off

Material: PVC

Unit of measure: PC

Article No.	Glass size	Size	Price (INR)
950.28.211	8 mm	2500 mm	330
950.28.212	10 mm	2500 mm	330
950.28.213	12 mm	2500 mm	360



Magnetic Seal: 180° and 90°

Application: To seal gap between 180° or 90° door and side panel using magnet

Material: PVC

Unit of measure: PR

Article No.	Glass size	Size	Price (INR)
950.28.206	8 mm	2500 mm	1,230
950.28.207	10 mm	2500 mm	1,230
950.28.208	12 mm	2500 mm	1,230



Magnetic Seal: 135°

Application: To seal gap between 135° door and side panel using magnet

Material: PVC

Unit of measure: PR

Article No.	Glass size	Size	Price (INR)
950.28.209	10 mm	2500 mm	1,230
950.28.210	12 mm	2500 mm	1,230

KNOBS

981.20.130



Back to back knob
 Glass thickness: 6 - 10 mm
 Size: 32 mm x 40 mm
 Finish: SS matt
 Material: SS 304
 Unit of measure: PR
 Price (INR): **2,165**

981.20.131



Back to back knob
 Glass thickness: 6 - 10 mm
 Size: 32 mm x 40 mm
 Finish: SS polished
 Material: SS 304
 Unit of measure: PR
 Price (INR): **2,250**

981.20.122

Special article**



Back to back knob
 Glass thickness: 6 - 10 mm
 Size: 38 mm x 40 mm
 Finish: SS matt
 Material: SS 304
 Unit of measure: PR
 Price (INR): **3,110**

981.20.123

Special article**



Back to back knob
 Glass thickness: 6 - 10 mm
 Size: 38 mm x 40 mm
 Finish: SS polished
 Material: SS 304
 Unit of measure: PR
 Price (INR): **3,175**

981.20.121

Special article**



Back to back knob
 Glass thickness: 6 - 10 mm
 Size: 32 mm x 40 mm
 Finish: SS polished
 Material: SS 304
 Unit of measure: PR
 Price (INR): **3,175**

981.79.100

Special article**



Back to back knob
 Glass thickness: 6 - 10 mm
 Size: 32 mm x 40 mm
 Finish: SS polished
 Material: SS 304
 Unit of measure: PR
 Price (INR): **1,445**

FLUSH HANDLES

981.20.140



Flush handle
 Application: Sliding glass door
 Glass thickness: 10 - 12 mm
 Cut-out for screw fixing Ø: 14.5 mm
 Finish: SS matt
 Material: SS 304
 Unit of measure: PC
 Price (INR): **4,795**

981.20.141 Special article**



Flush handle
 Application: Sliding glass door
 Glass thickness: 10 - 12 mm
 Cut-out for screw fixing Ø: 14.5 mm
 Finish: SS polished
 Material: SS 304
 Unit of measure: PC
 Price (INR): **5,335**

981.52.521



Flush handle
 Application: Sliding glass door
 Glass thickness: 8 - 10 mm
 Glass cut-out Ø: 48 mm
 Finish: SS matt
 Material: SS 304
 Unit of measure: PC
 Price (INR): **3,400**

981.52.531



Flush handle
 Application: Sliding glass door
 Glass thickness: 8 - 10 mm
 Glass cut-out Ø: 55 mm
 Finish: SS polished
 Material: SS 304
 Unit of measure: PC
 Price (INR): **4,605**

981.20.102



Flush handle
 Application: Sliding glass door
 Glass thickness: 10 - 12 mm
 Glass cut-out Ø: 55 mm
 Finish: SS matt
 Material: SS 304
 Unit of measure: PC
 Price (INR): **4,605**

981.20.110



Flush handle
 Application: Sliding glass door
 Glass thickness: 8 - 10 mm
 Glass cut-out Ø: 55 mm
 Finish: SS matt
 Material: SS 304
 Unit of measure: PC
 Price (INR): **3,950**

981.20.112



Flush handle
 Application: Sliding glass door
 Glass thickness: 10 - 12 mm
 Glass cut-out Ø: 55 mm
 Finish: SS matt
 Material: SS 304
 Unit of measure: PC
 Price (INR): **3,950**

Note: **Order to stock

GRAB BARS

903.19.764

Special article**



Shower header bar

Diameter: 32 mm
 Size: 450 mm C/C
 Finish: SS matt
 Material: SS 304
 Unit of measure: PC
 Price (INR): **2,475**

903.19.765

Special article**



Shower header bar

Diameter: 32 mm
 Size: 450 mm C/C
 Finish: SS polished
 Material: SS 304
 Unit of measure: PC
 Price (INR): **2,560**

903.19.774

Special article**



Shower header bar

Diameter: 32 mm
 Size: 600 mm C/C
 Finish: SS matt
 Unit of measure: PC
 Price (INR): **2,820**

903.19.775

Special article**



Shower header bar

Diameter: 32 mm
 Size: 600 mm C/C
 Finish: SS polished
 Material: SS 304
 Unit of measure: PC
 Price (INR): **2,900**



ECHO SHOWER SLIDING SYSTEM

DOOR CONTROL DEVICES
PATCH FITTINGS
PULL HANDLES
PARTITION SYSTEMS
OFFSET PIVOT HINGES
STILE DOOR HARDWARE
GLASS DOOR LOCKS
SHOWER FITTINGS
GLASS SLIDING SYSTEMS



Application: Complete set of fittings without track

Roller: Ball bearing

Set includes: 2 rollers, 2 anti-derail knobs, 1 sliding door flush handle, 2 roller stoppers, 2 wall supports, 1 bottom guide and 2 track supports

Unit of measure: SET

Article No.	Finish	Price (INR)
981.20.314	Stainless steel polished	14,980
981.20.315 Special article**	Stainless steel matt	14,980

Echo rectangular track

Article No.	Finish	Size	Price (INR)
981.20.316	Stainless steel polish	30 x 2000 mm	5,510
981.20.317 Special article**	Stainless steel polish	30 x 1600 mm	5,245
981.20.318 Special article**	Stainless steel matt	30 x 2000 mm	5,510
981.20.319 Special article**	Stainless steel matt	30 x 1600 mm	5,245

ELLE 80 SHOWER SLIDING SYSTEM



981.20.801

Weight carrying capacity: 80 kg
 Track length: 2500 mm
 Track material: Aluminium
 Roller material: Delrin
 Accessories Material: SS 304
 Set includes: 2 rollers, 1 track, 1 handle,
 1 floor guide, 2 end wall clips, 2 stoppers,
 3 gaskets for fixed glass
 Finish: SS polished
 Unit of measure: SET
 Price (INR): **14,995**

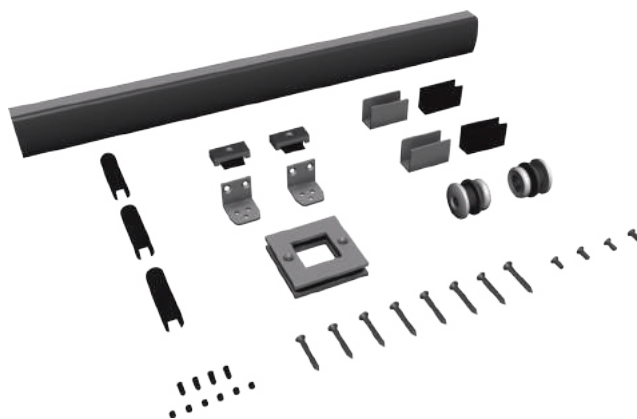

DOOR CONTROL
DEVICES

PATCH
FITTINGS

PULL
HANDLES

PARTITION
SYSTEMS

OFFSET PIVOT
HINGES

STILE DOOR
HARDWARE

GLASS DOOR
LOCKS

SHOWER
FITTINGS

GLASS SLIDING
SYSTEMS



Glass Sliding Systems

DESIGN ERGO 80





Application: For dividers and internal doors
 Max. door weight: 80 kg
 Max. glass door height: 3000 mm
 Max. glass door width: 1500 mm
 Gap between track and door: 10 mm
 Glass thickness: 10 - 12 mm
 Finish: SS polished
 Material: SS 304
 Price (INR): **6,509**





941.10.037

Sliding door kit consists of:
 2 rollers with bracket
 2 adjustable stoppers and other fittings
 2 glass clamps
 4 seals
 1 bottom guide

Article No.	Product	Length (mm)	Price (INR)
409.50.602	 Aluminium anodized top track (Note: Track to be ordered separately)	2100	1,865
941.27.432	 Aluminium anodized top track (Note: Track to be ordered separately)	3000	2,440

Optional

Article No.	Product	Thickness (mm)	Price (INR)
941.10.101	 Ergo sliding patch - 22 mm diameter Finish: SS polished Material: SS 304	-	2,473
940.66.060	 Wall mounting bracket	3	433

DESIGN 80 L











Max. door weight: 80 kg
 Max. glass door height: 3200 mm
 Max. glass door width: 1500 mm
 Gap between track and door: 4 - 10 mm
 Glass thickness: 8 - 10 mm
 Compatible with installation on false ceiling
 No glass preparation (cut-out) required.

Price (INR): **23,336**



940.99.091

Sliding door kit consists of:
 2 rollers with bracket
 2 adjustable stoppers
 1 bottom guide and other fittings

Article No.	Product	Length (mm)	Price (INR)
940.99.931	 Silver anodized aluminium double track for false ceiling application with fixed glass (Note: Track to be ordered separately)	3000	16,832
941.27.432	 Aluminium anodized top track (Note: Track to be ordered separately)	3000	2,440
940.99.830	 Silver anodized aluminium track for fixed glass (Note: Track to be ordered separately)	3000	13,930
940.99.730	 Silver anodized aluminium trim cover (Note: Trim cover to be ordered separately)	3000	6,647
943.39.815	 Bottom track for fixed glass (Note: Track to be ordered separately)	3000	2,361
940.99.731	 Aluminium trim cover with stainless steel finish (Note: Trim cover to be ordered separately)	3000	11,467
940.99.130	 Trim cover for profile- fixed glass (Note: Trim cover for to be ordered separately)	3000	1,516
940.99.061	 End trim cover for glass thickness 8 mm (Note: End trim cover to be ordered separately)	-	388
940.99.062	 End trim cover for glass thickness 10 mm (Note: End trim cover to be ordered separately)	-	439

DESIGN 80 M



Patented product that guarantees functionality with enhanced aesthetics
 Max. door weight: 80 kg
 Max. glass door height: 3000 mm
 Glass door width: Max. 1500 mm - Min 900 mm
 Glass thickness: 10 - 12 mm
Price (INR): 53,328

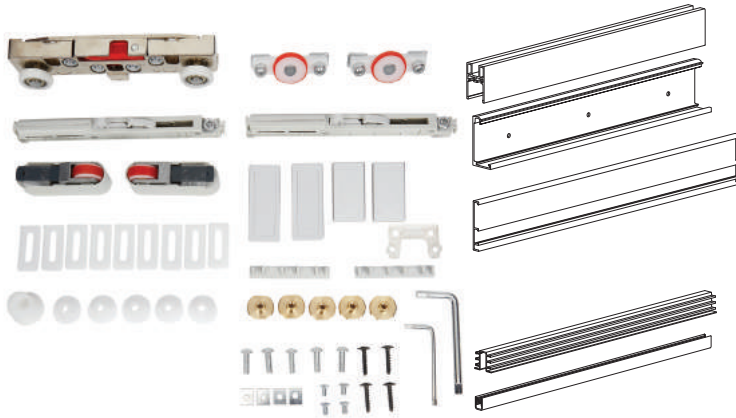

940.59.007

- Sliding door kit consists of:
- Top track profile
 - Bottom guide
 - Top track
 - Housing for bottom gear
 - Bottom track profile
 - Bottom running gear
 - Bottom track
 - Fixing brackets for top gear
 - Cover caps for top track
 - Top running gear
 - Cover caps for top track profile
 - Damping mechanism for top track
 - Cover caps for bottom track
 - Distance spacers
 - Allen key and fixing screws

DESIGN 85 SV



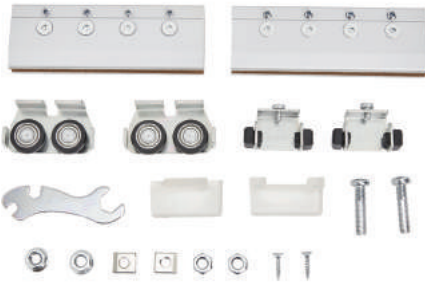

Max. door weight: 85 kg
 Max. glass door height: 3200 mm
 Max. glass door width: 1500 mm
 Glass thickness: 8-10 mm
 Compatible with installation on false ceiling
 No glass preparation (cut-out) required.
Price (INR): 22,762





940.99.094

Sliding door kit consists of:
 2 rollers with bracket
 2 adjustable stoppers and other fittings
 2 screws
 1 bottom guide

Article No.	Product	Length (mm)	Price (INR)
940.99.630	 Silver anodized top track (Note: Track to be ordered separately)	3000	7,895
940.99.650		5000	13,155
940.99.530	 Silver aluminium anodized trim cover (Note: Track to be ordered separately)	3000	8,739
940.99.550		5000	14,561

Optional

Article No.	Product	Price (INR)
940.99.093	 Aluminium separator	55
940.99.081	 Trim cover support	574
940.99.082	 Wall mounting bracket	345

DESIGN 80 SYTL





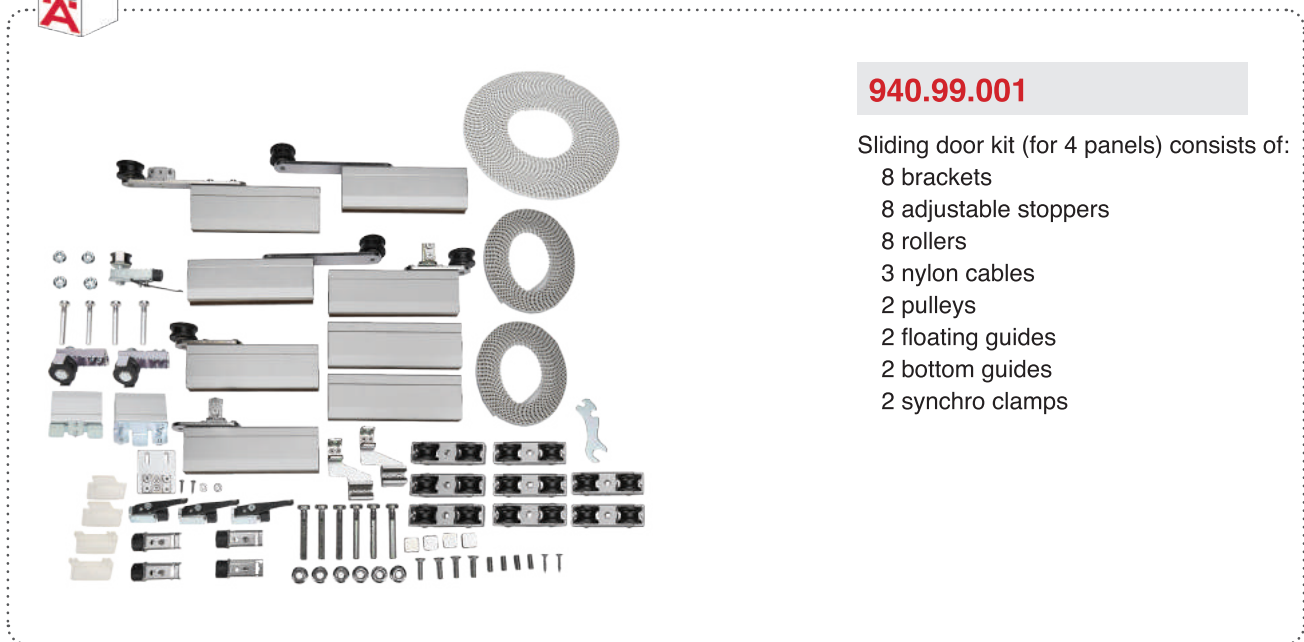

Max. door weight: 80 kg
 Max. glass door height: 2400 mm
 Max. glass door width: 1200 mm
 Glass thickness: 8-10 mm
 No glass preparation (cut-out) required.
 Price (INR): **1,59,433**



940.99.001

Sliding door kit (for 4 panels) consists of:
 8 brackets
 8 adjustable stoppers
 8 rollers
 3 nylon cables
 2 pulleys
 2 floating guides
 2 bottom guides
 2 synchro clamps

Article No.	Product	Length (mm)	Price (INR)
940.99.932	 Upper track (Note: Track to be ordered separately)	3000	10,998
943.39.815	 Bottom track for fixed glass (Note: Track to be ordered separately)	3000	2,361
940.99.080	 Aluminium anodized separator support for trim cover	-	1,106
940.99.081	 Trim cover support	-	574
940.99.732	 Aluminium anodized trim cover	3000	8,006

DESIGN 80 SY







Max. door weight: 80 kg
 Max. glass door height: 3000 mm
 Max. glass door width: 1500 mm
 Glass thickness: 8 - 10 mm
 Compatible with installation on false ceiling
 No glass preparation (cut-out) required.
 Price (INR): **75,456**





940.99.092

Sliding kit consists of (for synchronised doors):
 4 rollers with bracket
 4 adjustable stoppers
 2 pulleys
 1 synchro cable and other fittings

Article No.	Product	Length (mm)	Price (INR)
940.99.930	 Silver anodized aluminium track (Note: Track to be ordered separately)	3000	6,681
940.99.830	 Silver anodized aluminium track for fixed glass (Note: Track to be ordered separately)	3000	13,930
943.39.815	 Bottom track for fixed glass	3000	2,361
940.99.730	 Silver anodized aluminium trim cover (Note: Trim cover to be ordered separately)	-	6,647
940.99.093	 Aluminium separator (Note: Aluminium separator to be ordered separately)	-	55

Optional

Article No.	Product	Length (mm)	Price (INR)
940.99.081	 Trim cover support	3000	574
943.39.031	 Wall support	3000	235
943.39.032	 Profile end trim	3000	321

DESIGN 200





Max. door weight: 200 kg
 Max. glass door height: 3000 mm
 Max. glass door width: 1500 mm
 Glass thickness: 10 - 12 mm
 Gap between track and door: 16 - 27 mm
 No glass preparation (cut-out) required.
 Finish: SS polished
 Material: SS 304
 Price (INR): **36,635**





942.63.090

Sliding door kit consists of:
 2 rollers with brackets
 2 adjustable stoppers
 1 bottom guide

Article No.	Product	Length (mm)	Price (INR)
942.63.930	 Silver anodized aluminium top track for fixed glass (Note: Track to be ordered separately)	3000	20,533
942.63.950		5000	34,226

Article No.	Product	Length (mm)	Price (INR)
943.39.930	 Silver anodized aluminium top track, 3mm (Note: Track to be ordered separately)	3000	28,595
943.39.945		4500	42,895

Article No.	Product	Length (mm)	Price (INR)
942.63.830	 Silver anodized aluminium trim cover, 3mm (Note: Trim cover to be ordered separately)	3000	11,723
942.63.850		5000	19,535

Article No.	Product	Length (mm)	Price (INR)
943.39.815	 Silver anodized aluminium bottom track (Note: Track to be ordered separately)	3000	2,361

DESIGN 100 SF 101

DOOR CONTROL
DEVICES

PATCH
FITTINGS

PULL
HANDLES

PARTITION
SYSTEMS

OFFSET PIVOT
HINGES

STILE DOOR
HARDWARE

GLASS DOOR
LOCKS









SHOWER
FITTINGS

GLASS SLIDING
SYSTEMS





Max. door weight: 50 kg
Max. glass door height: 2650 mm
Max. glass door width: 745 mm
Glass thickness: 8 - 10 mm
Gap between track and door: 3 - 5 mm

Sliding system components:

Article No.	Product	Price (INR)
943.39.020	 Single hinge roller	33,561
943.39.022	 Bottom guide with single hinge	23,677
943.39.023	 Central roller double hinge	43,766
943.39.024	 Double hinge with base pin	25,489
943.39.026	 Central bottom guide double hinge	32,687
943.39.027	 Top pivot with hinge	30,365
943.39.028	 Bottom hinge with pivot	25,653
943.39.029	 Bottom hinge with bolt	14,862

Tracks

Article No.	Product	Length (mm)	Price (INR)
943.39.930	 Silver anodized aluminium top track (Note: Track to be ordered separately)	3000	28,595
943.39.945		4500	42,895
943.39.830	 Silver anodized aluminium bottom track (Note: Track to be ordered separately)	3000	4,717
943.39.845		4500	7,076

Optional

Article No.	Product	Price (INR)
943.39.025	 Optional Double Hinge 'A' Central (Note: For doors higher than 2400 mm it is necessary to install patch-hinges)	22,711
943.39.030	 Optional Double Hinge 'B' Central (Note: For doors higher than 2400 mm it is necessary to install patch-hinges)	22,725

DESIGN TELESCOPIC PROGRESSIVE 80



Max. door weight: 80 kg
 Max. glass door height: 2650 mm
 Max. glass door width: 745 mm
 Glass thickness: 8 - 10 mm
 Gap between track and door: 3 - 5 mm

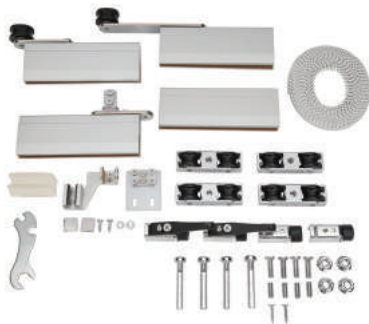

941.27.436

Kit for two doors
 Sliding kit consists of:
 4 rollers
 4 carriage set
 4 stoppers
 1 fixed bottom guide
 1 floating bottom guide
 2 pulley
 1 belt
 1 supporting brackets and accessories

Price (INR): **92,861**

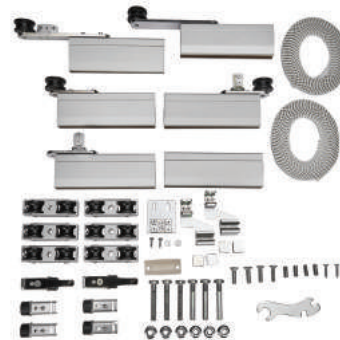

941.27.437

Kit for three doors
 Sliding kit consists of:
 6 rollers
 6 carriage set
 6 stoppers
 1 fixed bottom guide
 2 floating bottom guides
 4 pulleys
 2 belts
 1 supporting brackets and accessories

Price (INR): **1,35,136**

Article No.	Product	Length (mm)	Price (INR)
940.99.604	 Aluminium anodized top track (Note: Track to be ordered separately)	3600	9,432

GLOSSARY

Cycle Testing	Includes both internal and external lab testing. Test result varies for different products.
EPDM	Ethylene Propylene Diene Monomer
PC	Piece
PR	Pair
Salt Spray Testing	A salt spray test is a corrosion testing method that uses high-saline environments to measure the corrosion resistance of products and coatings over extended periods.
Special Article	Order for these articles usually involves a Minimum Order Quantity (MOQ) and a Lead Time. Please contact your Hafele Sales Representative for more details.
SS Matt	Stainless steel matt finish
SS Polished	Stainless steel polished finish
SS 304	Stainless steel grade 304
SS 304 Cover Plate	The outer cover is made of Stainless Steel Grade 304, the inner product components / body could be made of different materials.
Warranty	Warranty for all products is only functional in nature. Please refer to the terms and conditions in detail by clicking www.hafeleindia.com

Note: Prices are subject to change. We reserve the right to change our product prices at any time without further notice.